



NOP, NOT and NOX



Adaptable, flexible supply
air diffusers with ultra low height
for free installation

NOP, NOT and NOX

The most outstanding features of the NOP, NOT and NOX supply air diffusers are their excellent adaptability and flexibility, as well as precise and clear adjustment based on pressure difference. Whenever the layout or use of the space changes, the throw pattern may always be redirected to achieve the best possible, draught-free air distribution.

NOP, NOT and NOX, with their ultra low construction height, are exceptionally easy and quick to clean thanks to the opening adjustment section. These products, intended for visible installation, have excellent air and sound properties. Their mounting allows easy adjustment of the installation height.



Supply air diffusers for free installation

NOP, **NOT** and **NOX** are extremely adaptable and flexible. They can be changed to be more suitable for either cooling or heating if the use of the rooms changes during the product's lifecycle.

NOP and **NOT** are especially suited for isothermal and low temperature air.

NOX is particularly designed for handling overtemperature air. A unique characteristic of NOX is the possibility to turn the vertical throw pattern 30 degrees to the side. This is a huge advantage if the throw pattern becomes obstructed, for example due to changes in the room's layout.

NOP



The patented nozzle structure deflects even low temperature air in the desired direction.

NOT



The uniquely even nozzle surface creates a stylish appearance.

NOX



NOX, designed for overtemperature air management, follows the same design ideology as the outstandingly successful RIX and RUX. It is intended for low installation heights, for example in supermarkets and shops.

New innovative adjustment unit

The new adjustment unit provides more accurate and precise adjustment than ever before. Both adjustment and measuring is performed through the patented adjustment unit. The adjustment setting is simply read from the display disc with numbering corresponding to the different k values. The measurement is based on static pressure difference over the adjustment unit. This gives accurate and reliable measurement even with small pressure differences and low air velocities. The adjustment setting can be locked.

Benefits of the flexibility of NOX

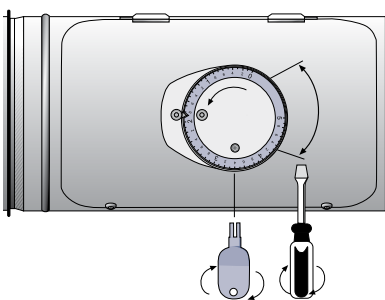
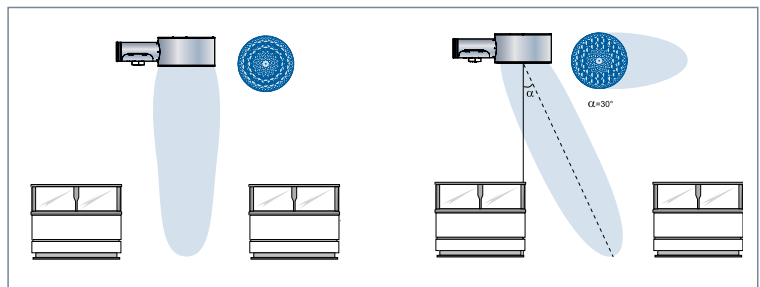

The unit is adjusted using an adjustment key or, for example, a screwdriver. The adjustment disc numbers correspond to the different k values.

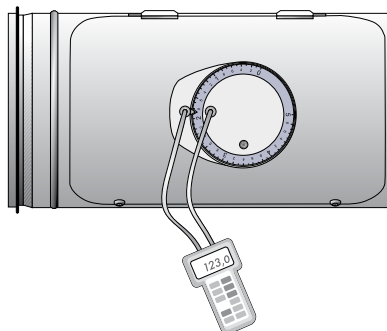

Pressure difference is measured from the connections on the adjustment unit.

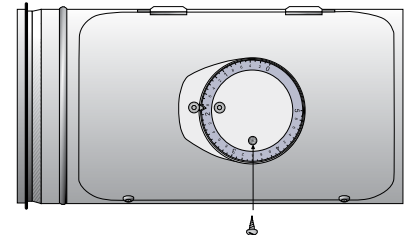

The adjustment setting can be locked with a screw if desired.

Model S, quieter than a whisper

The special diffuser models NOP-S, NOT-S and NOX-S have been developed for sites and spaces with especially high sound level requirements. Sounds from adjustment and throttling are efficiently dampened before the diffuser unit. The solution is visually very stylish as the channel size remains unchanged.

Adjustment is performed exactly as in standard models. Typical application sites include schools, offices and day-care centres. The S versions are also well suited for renovation projects where large throttling capacity is required. The dampening material meets cleanliness class M1 requirements.



Dimensions

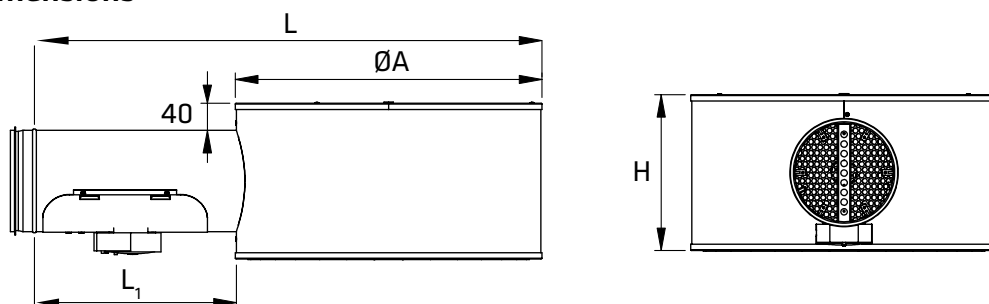

	nom. Ød	ØA	L	H	L ₁	kg
NOP, NOT, NOX-125	125	386	726	205	340	5,1
NOP, NOT, NOX-160	160	475	875	240	400	7,5
NOP, NOT, NOX-200	200	580	1015	280	435	10,0
NOP, NOT, NOX-250	250	638	1113	330	475	12,0
NOP, NOT, NOX-315	315	638	1163	395	525	15,0

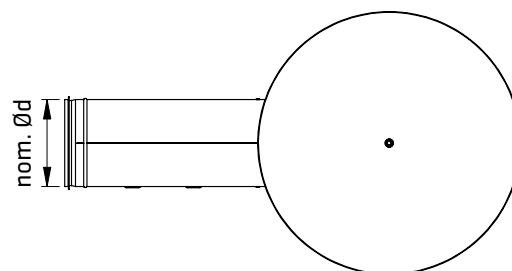

S-Model

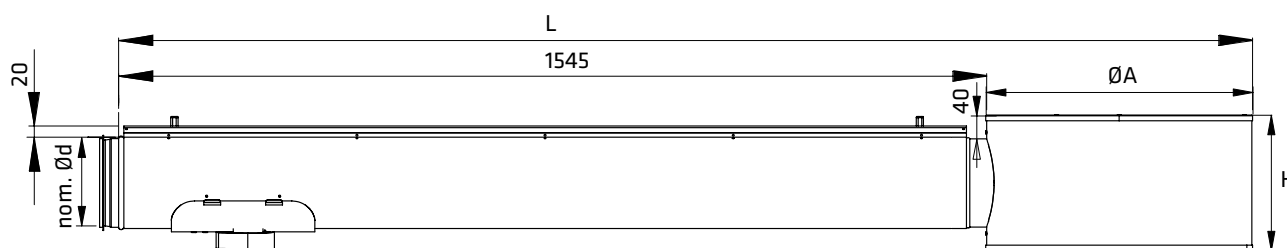

	nom. Ød	ØA	L	H	kg
NOP-S, NOT-S, NOX-S-125	125	386	1931	205	8,7
NOP-S, NOT-S, NOX-S-160	160	475	2020	240	12,1
NOP-S, NOT-S, NOX-S-200	200	580	2125	280	16,9
NOP-S, NOT-S, NOX-S-250	250	638	2183	330	22,4
NOP-S, NOT-S, NOX-S-315	315	638	2183	395	27,5

Low structural height is specially beneficial in low spaces.

Quick guide

Sound level lower than 35 dB(A) at 50 Pa total pressure (dm³/s)

	NOT	NOP	NOX
125	20-60	20-60	40-65
160	30-85	25-85	65-85
200	50-120	50-110	70-120
250	70-190	70-180	90-200
315	110-205	110-205	100-260

NOTE! Model S achieves low sound levels even at significantly higher total pressure Pa values!

Easy installation

NOP, NOT and NOX provide unparalleled ease, reliability and speed of installation. The installation height can be simply changed and fine-tuned until the completion of installation. The wide adjustment range of installation height does not require an exact threadbar length. The top of the unit can be installed touching the ceiling. A specially designed adjustment key is delivered with the product.

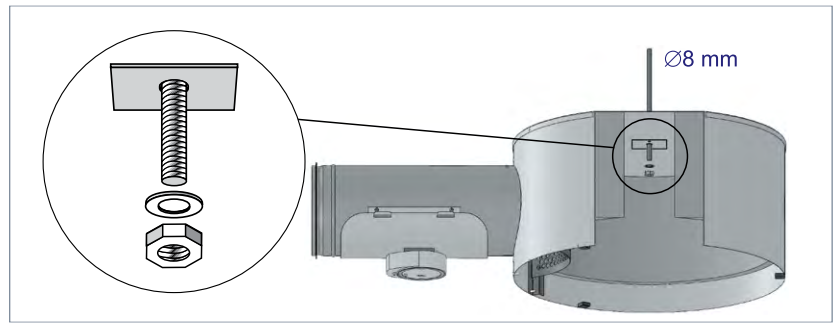

The threadbar is fixed from inside the diffuser, meaning that its length does not need to be particularly accurate. It also enables mounting direct to ceiling.

Minimum distances

The recommended minimum distances after bend, T branch and T joint.

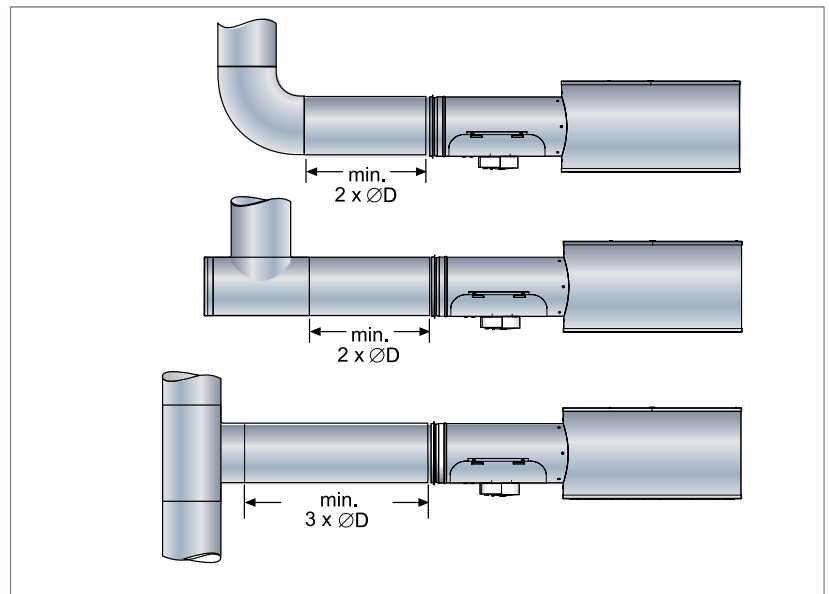

Service and cleaning

Service and cleaning are essential components affecting total lifecycle costs. The nozzle plate is quickly detached thanks to its innovative attachment. The airflow balancing plate inside comes off easily. One of the unique properties of the product is how easy it is to remove the adjustment unit—thereby creating a cleaning opening that fulfils all regulations. All this original thinking make the product easy to clean completely and swiftly, not least because inserting the brush into the duct is so effortless.

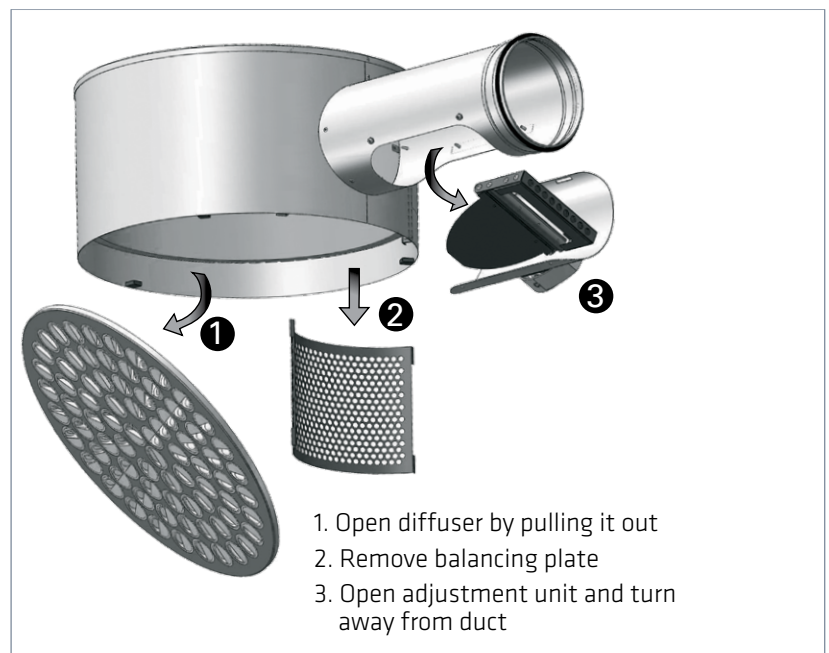

Materials

The products are manufactured from galvanised steel, the directable nozzles from plastics. Colour options: Traffic White RAL 9016, Grey Aluminium RAL 9007+9023 or Jet Black RAL 9005.

Throw patterns NOP and NOT

Nozzles in twist-supply position

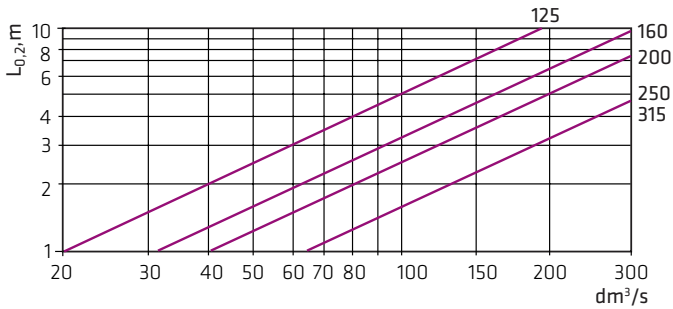
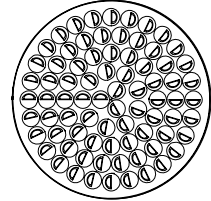
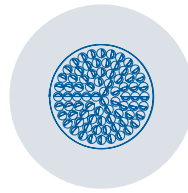
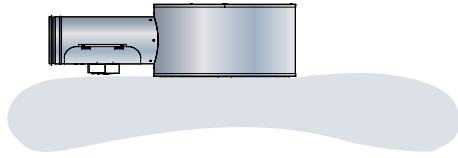

Conversion factors NOP and NOT

Nozzles in twist-supply position	1
Nozzles in one direction	2.8
Nozzles fanned out 90°	2.2
Nozzles outward	1.3
Nozzles fanned out in two directions 2 x 90°	1.7

Alternative throw patterns NOP and NOT

Nozzles in one direction

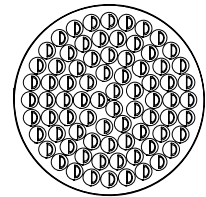
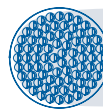
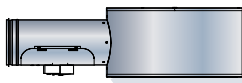

Nozzles fanned out 90°

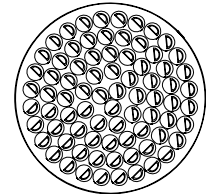
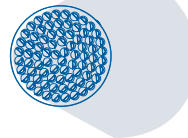
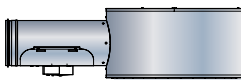

Nozzles outward

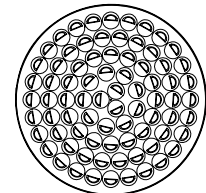
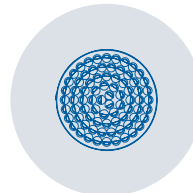
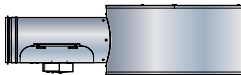

Nozzles fanned out in two directions 2 x 90°

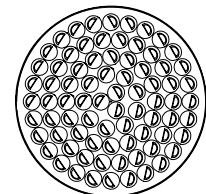
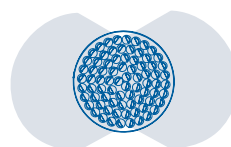
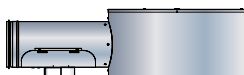

Throw patterns NOX

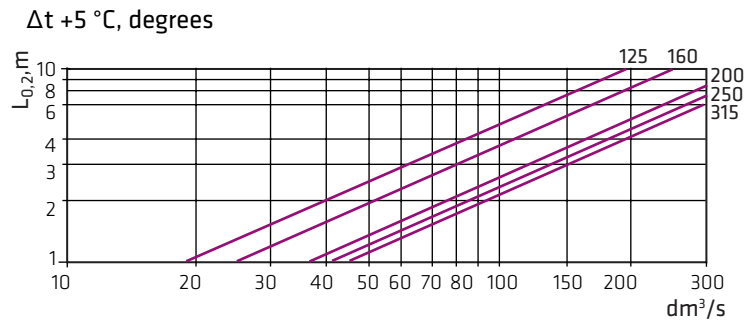
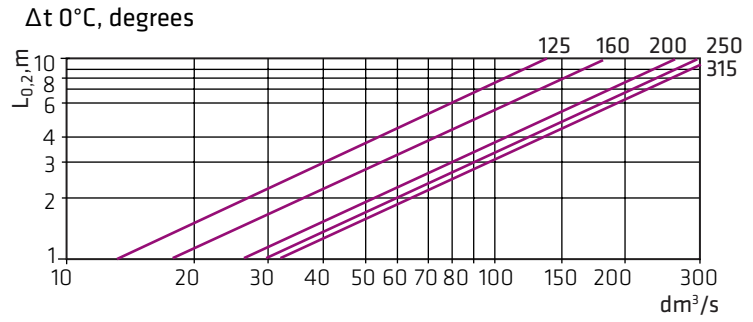
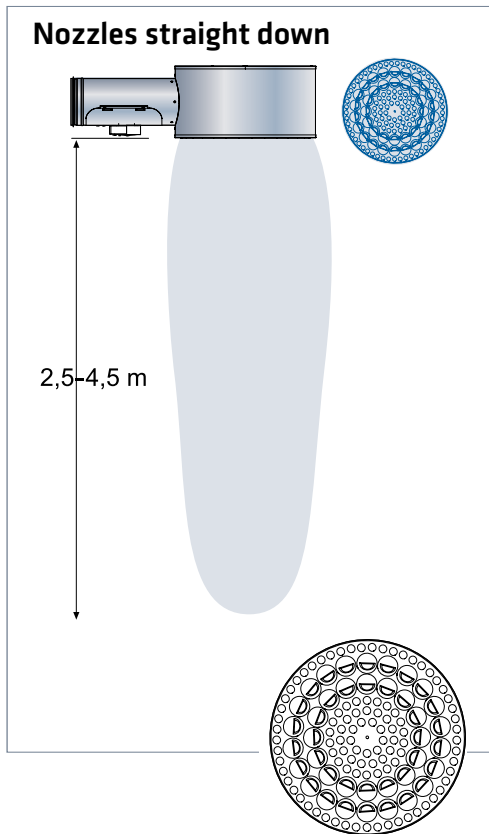

Conversion factors NOX

Nozzles straight down	1
Nozzles in twist-supply position	0,6
Nozzles turned 30° sideways	0,9

Alternative throw patterns NOX

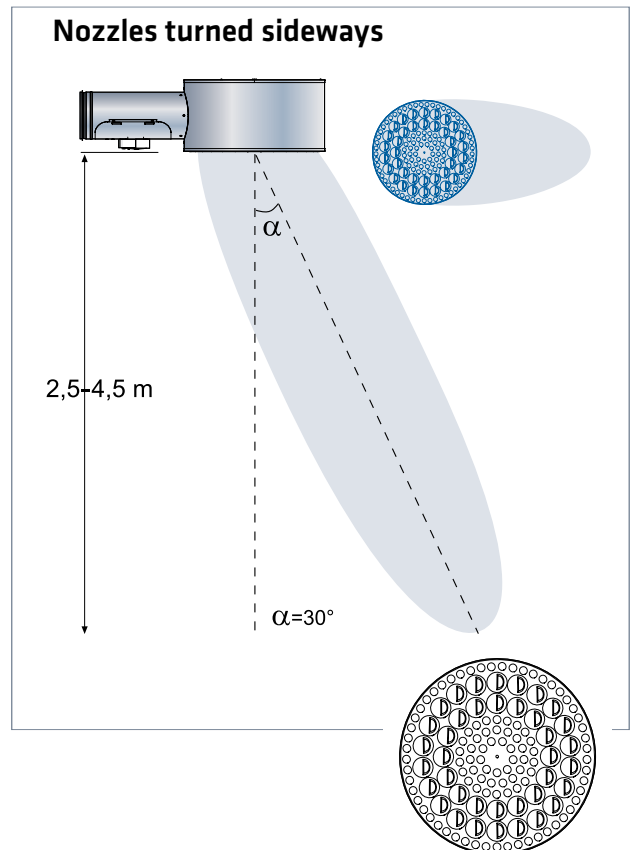
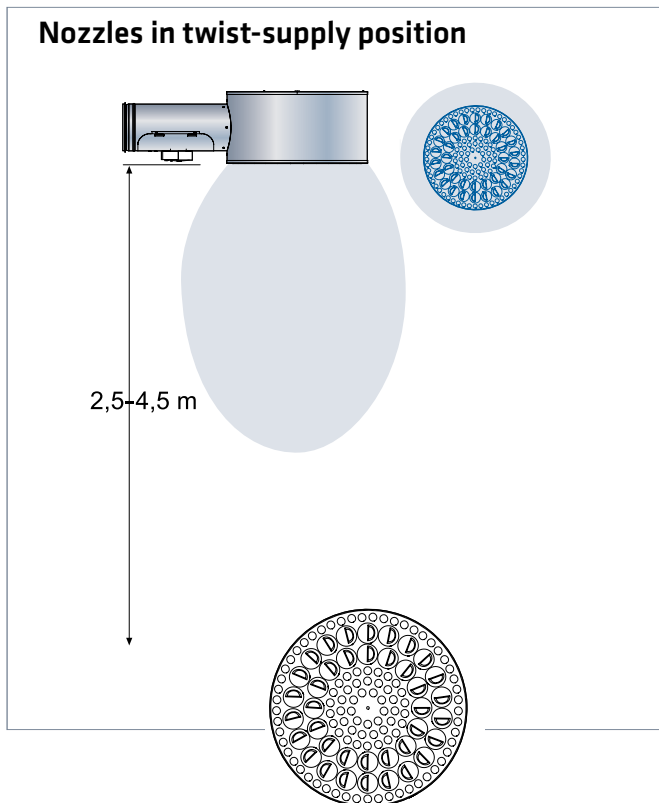

NOTE! For forced-air heating, also see products RIX and RUX.

NOP dimensioning Airflow - pressure loss - sound level. The graphs are not to be used for adjustment.

NOP-125

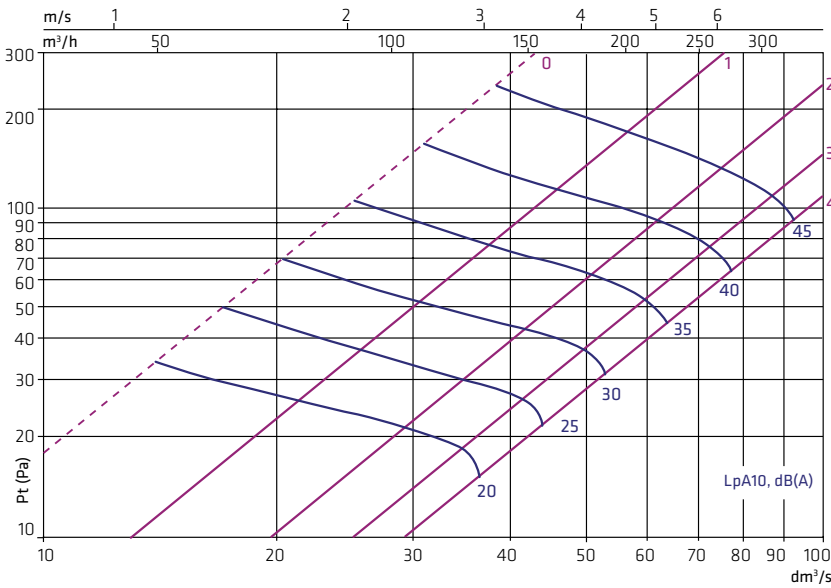

$L_{w\text{okt}} = L_{pA10} + K$								
f, Hz	63	125	250	500	1k	2k	4k	8k
K, dB	7	6	10	1	-5	-8	-10	-16
ΔL (dB)								
f, Hz	63	125	250	500	1k	2k	4k	8k
ΔL, dB	22	16	10	10	14	10	11	14

NOP-160

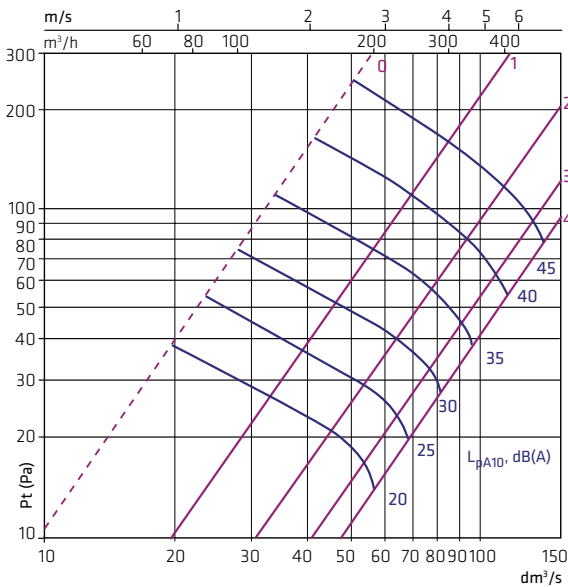

$L_{w\text{okt}} = L_{pA10} + K$								
f, Hz	63	125	250	500	1k	2k	4k	8k
K, dB	9	8	8	2	-3	-9	-11	-17
ΔL (dB)								
f, Hz	63	125	250	500	1k	2k	4k	8k
ΔL, dB	18	15	9	11	11	8	10	13

NOP-200

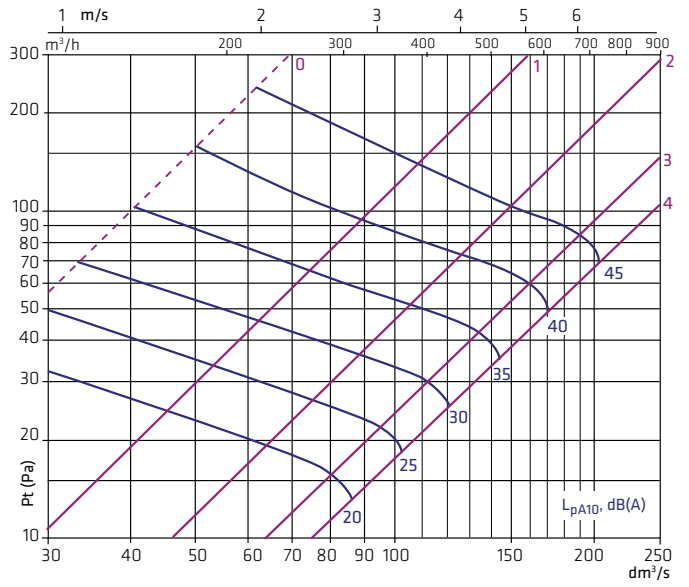

$L_{w\text{okt}} = L_{pA10} + K$								
f, Hz	63	125	250	500	1k	2k	4k	8k
K, dB	2	9	7	2	-3	-8	-11	-18
ΔL (dB)								
f, Hz	63	125	250	500	1k	2k	4k	8k
ΔL, dB	18	12	7	9	10	10	12	10

NOP dimensioning Airflow - pressure loss - sound level. The graphs are not to be used for adjustment.

NOP-250

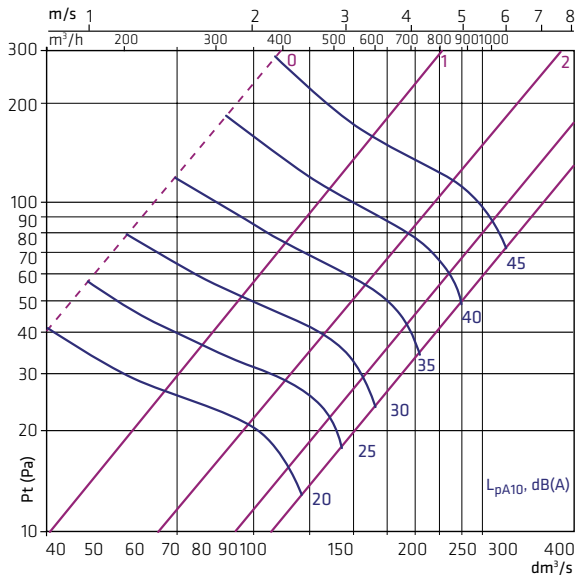

$$L_{w\text{okt}} = L_{pA10} + K$$

f, Hz	63	125	250	500	1k	2k	4k	8k
K, dB	6	11	8	4	0	-8	-11	-18

ΔL (dB)

f, Hz	63	125	250	500	1k	2k	4k	8k
ΔL, dB	16	8	7	9	8	8	9	12

NOP-315

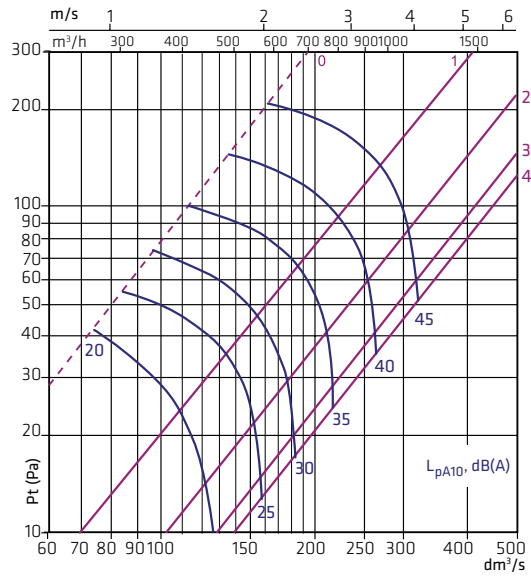

$$L_{w\text{okt}} = L_{pA10} + K$$

f, Hz	63	125	250	500	1k	2k	4k	8k
K, dB	8	11	7	5	2	-7	-11	-18

ΔL (dB)

f, Hz	63	125	250	500	1k	2k	4k	8k
ΔL, dB	14	8	10	9	6	8	10	13

NOP-S dimensioning Airflow - pressure loss - sound level. The graphs are not to be used for adjustment.

NOP-S-125

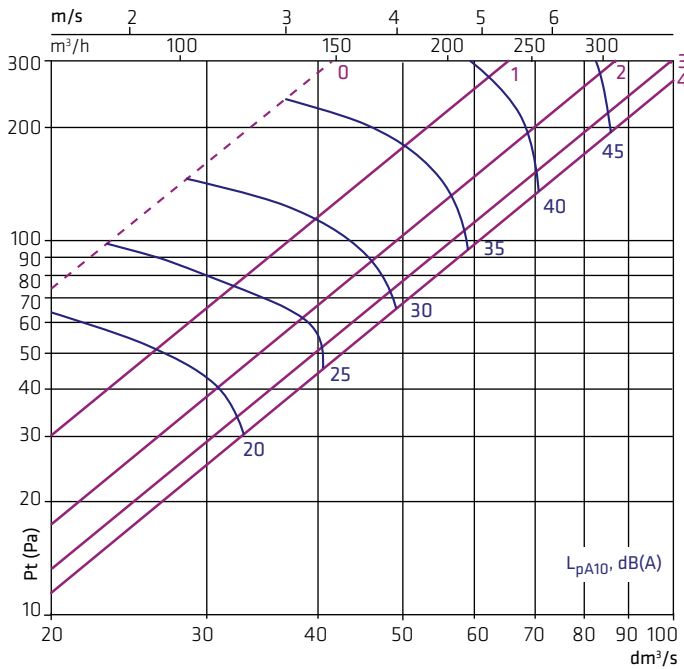

$$L_{w\text{okt}} = L_{pA10} + K$$

f, Hz	63	125	250	500	1k	2k	4k	8k
K, dB	2	7	11	-1	-6	-11	-14	-20

ΔL (dB)

f, Hz	63	125	250	500	1k	2k	4k	8k
ΔL, dB	33	21	16	25	36	33	30	27

NOP-S-160

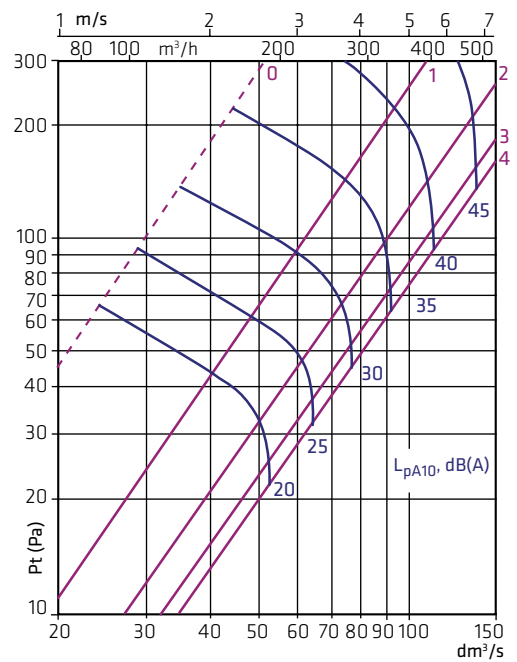

$$L_{w\text{okt}} = L_{pA10} + K$$

f, Hz	63	125	250	500	1k	2k	4k	8k
K, dB	4	10	10	0	-6	-12	-16	-21

ΔL (dB)

f, Hz	63	125	250	500	1k	2k	4k	8k
ΔL, dB	26	18	12	22	29	30	27	21

NOP-S-200

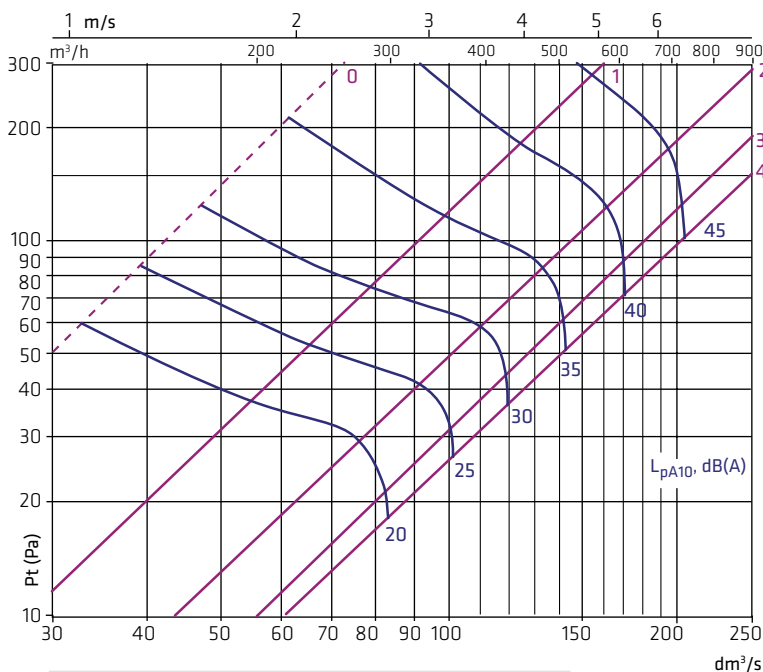

$$L_{w\text{okt}} = L_{pA10} + K$$

f, Hz	63	125	250	500	1k	2k	4k	8k
K, dB	4	11	9	1	-5	-12	-14	-22

ΔL (dB)

f, Hz	63	125	250	500	1k	2k	4k	8k
ΔL, dB	20	13	9	16	26	30	26	19

NOP-S dimensioning Airflow - pressure loss - sound level. The graphs are not to be used for adjustment.

NOP-S-250

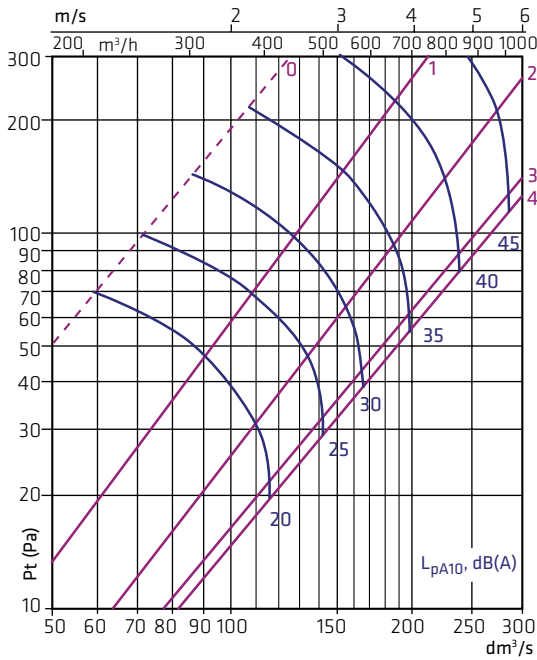

$L_{w_{okt}} = L_{pA10} + K$

f, Hz	63	125	250	500	1k	2k	4k	8k
K, dB	10	13	8	3	-1	-9	-12	-14

ΔL (dB)

f, Hz	63	125	250	500	1k	2k	4k	8k
ΔL , dB	17	11	14	21	26	27	24	20

NOP-S-315

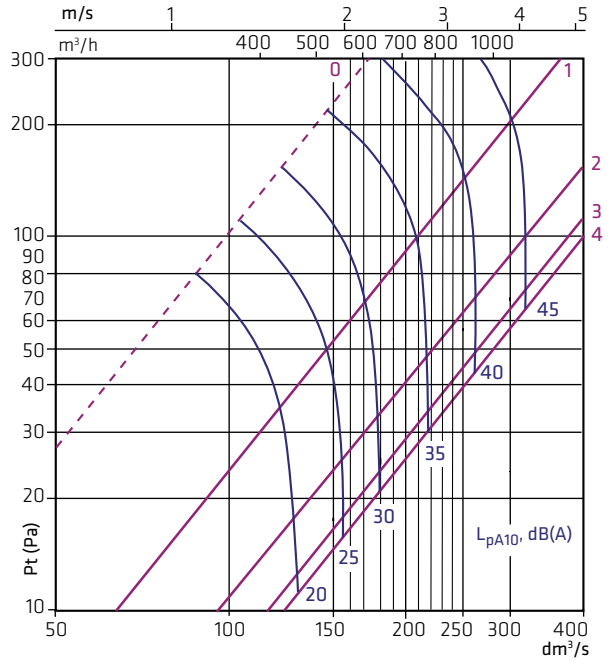

$L_{w_{okt}} = L_{pA10} + K$

f, Hz	63	125	250	500	1k	2k	4k	8k
K, dB	6	13	7	5	2	-8	-11	-18

ΔL (dB)

f, Hz	63	125	250	500	1k	2k	4k	8k
ΔL , dB	20	9	14	19	20	24	19	25

NOT dimensioning Airflow - pressure loss - sound level. The graphs are not to be used for adjustment.

NOT-125

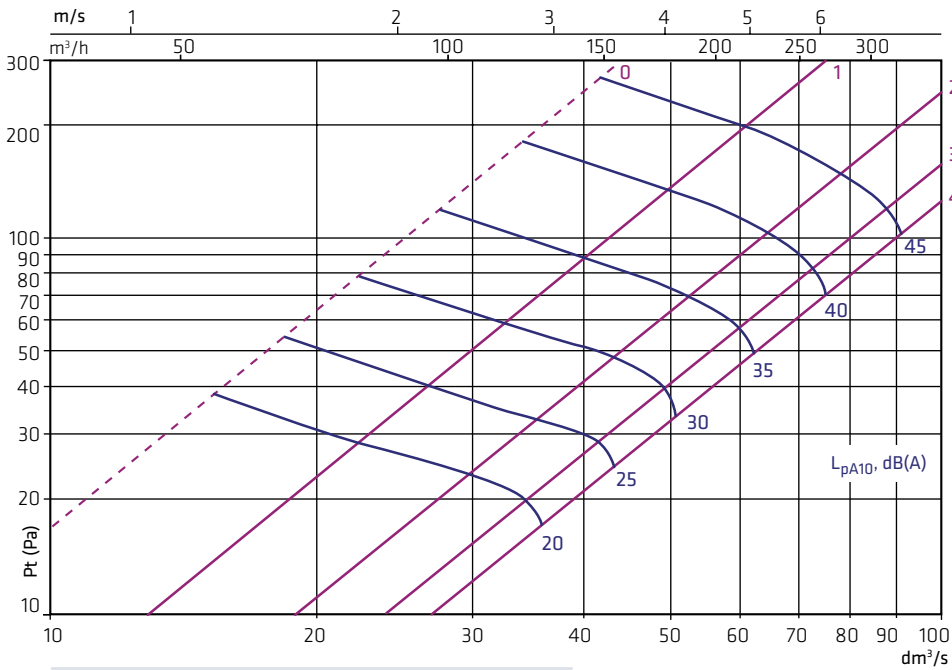

$$L_{w\text{okt}} = L_{pA10} + K$$

f, Hz	63	125	250	500	1k	2k	4k	8k
K, dB	7	7	10	1	-5	-10	-13	-14

ΔL (dB)

f, Hz	63	125	250	500	1k	2k	4k	8k
ΔL, dB	21	16	10	11	15	12	13	13

NOT-160

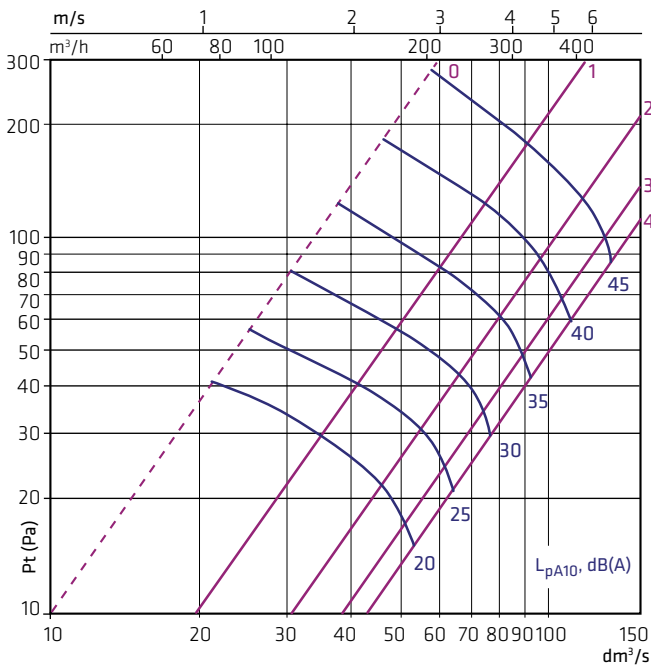

$$L_{w\text{okt}} = L_{pA10} + K$$

f, Hz	63	125	250	500	1k	2k	4k	8k
K, dB	9	9	8	2	-3	-9	-14	-16

ΔL (dB)

f, Hz	63	125	250	500	1k	2k	4k	8k
ΔL, dB	18	15	10	12	12	11	12	12

NOT dimensioning Airflow - pressure loss - sound level. The graphs are not to be used for adjustment.

NOT-200

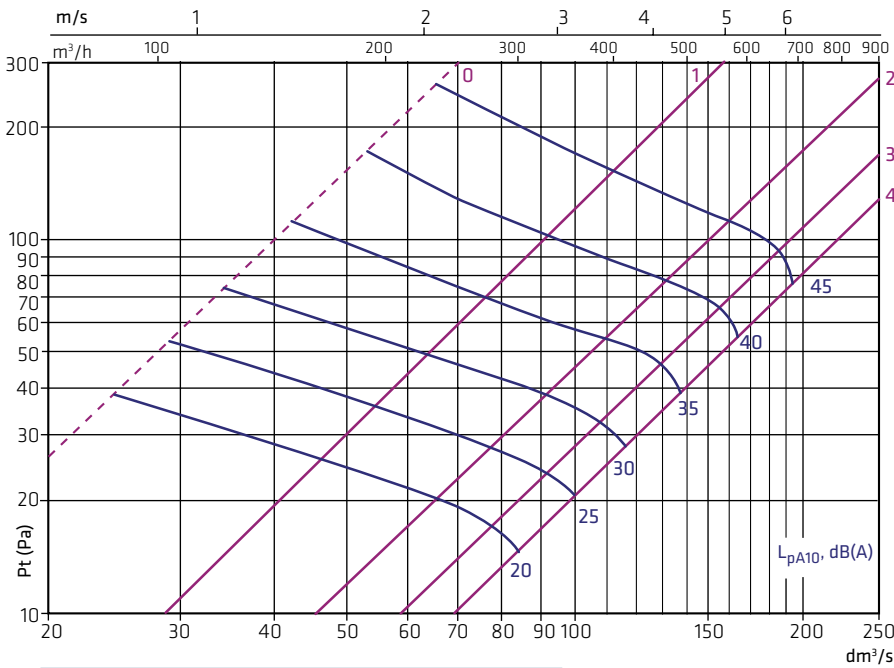

$L_{w\text{okt}} = L_{pA10} + K$

f, Hz	63	125	250	500	1k	2k	4k	8k
K, dB	3	10	7	2	-2	-8	-14	-22

ΔL (dB)

f, Hz	63	125	250	500	1k	2k	4k	8k
ΔL , dB	18	12	7	9	10	10	12	10

NOT-250

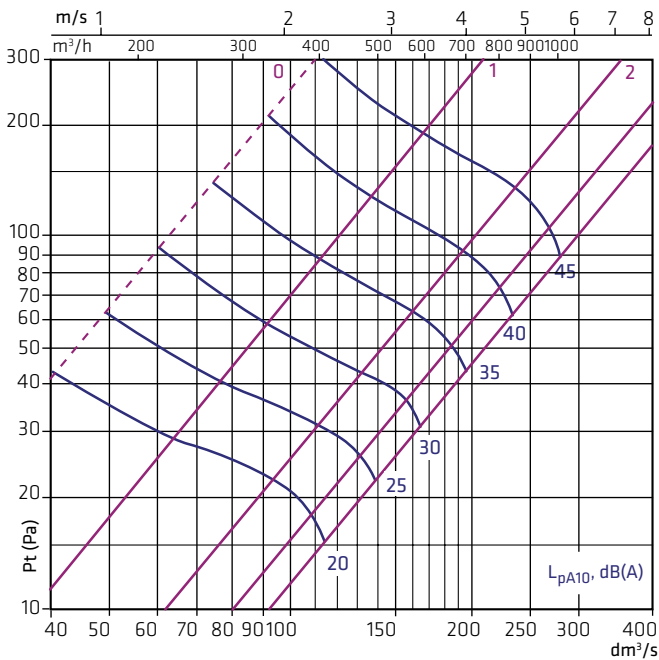

$L_{w\text{okt}} = L_{pA10} + K$

f, Hz	63	125	250	500	1k	2k	4k	8k
K, dB	4	12	8	4	-1	-8	-14	-18

ΔL (dB)

f, Hz	63	125	250	500	1k	2k	4k	8k
ΔL , dB	17	8	8	10	9	10	12	11

NOT-315

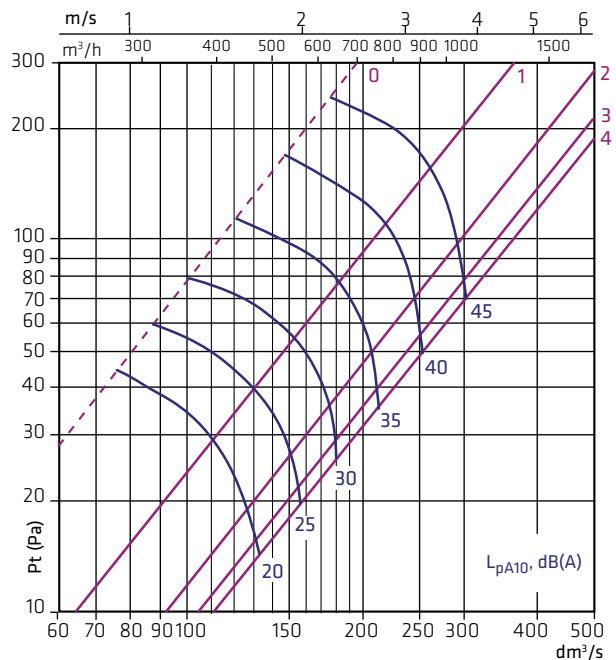

$L_{w\text{okt}} = L_{pA10} + K$

f, Hz	63	125	250	500	1k	2k	4k	8k
K, dB	7	13	8	5	2	-6	-13	-19

ΔL (dB)

f, Hz	63	125	250	500	1k	2k	4k	8k
ΔL , dB	14	8	10	9	7	10	13	11

NOT-S dimensioning Airflow - pressure loss - sound level. The graphs are not to be used for adjustment.

NOT-S-125

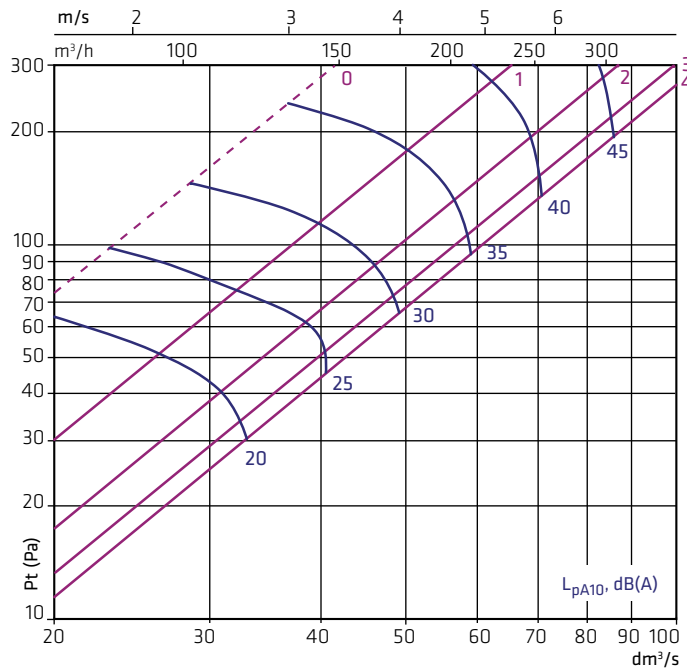

$L_{w\text{okt}} = L_{pA10} + K$

f, Hz	63	125	250	500	1k	2k	4k	8k
K, dB	1	8	11	-1	-6	-11	-15	-16

ΔL (dB)

f, Hz	63	125	250	500	1k	2k	4k	8k
ΔL , dB	33	21	16	26	37	33	30	27

NOT-S-160

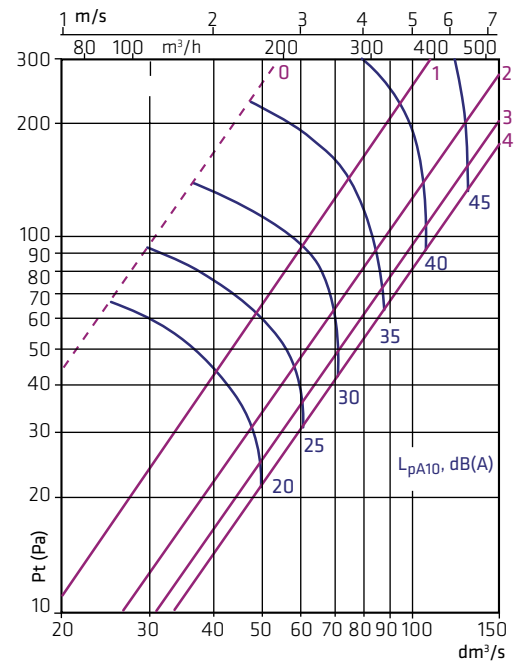

$L_{w\text{okt}} = L_{pA10} + K$

f, Hz	63	125	250	500	1k	2k	4k	8k
K, dB	3	11	10	0	-6	-11	-16	-20

ΔL (dB)

f, Hz	63	125	250	500	1k	2k	4k	8k
ΔL , dB	26	17	13	22	29	30	27	21

NOT-S-200

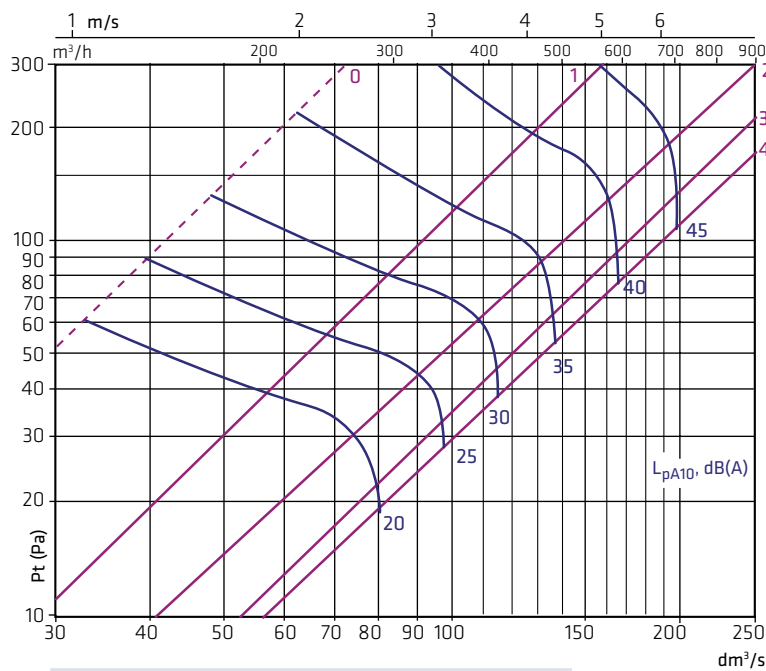

$L_{w\text{okt}} = L_{pA10} + K$

f, Hz	63	125	250	500	1k	2k	4k	8k
K, dB	3	11	9	1	-5	-11	-14	-17

ΔL (dB)

f, Hz	63	125	250	500	1k	2k	4k	8k
ΔL , dB	20	13	10	17	27	30	26	19

NOT-S dimensioning Airflow - pressure loss - sound level. The graphs are not to be used for adjustment.

NOT-S-250

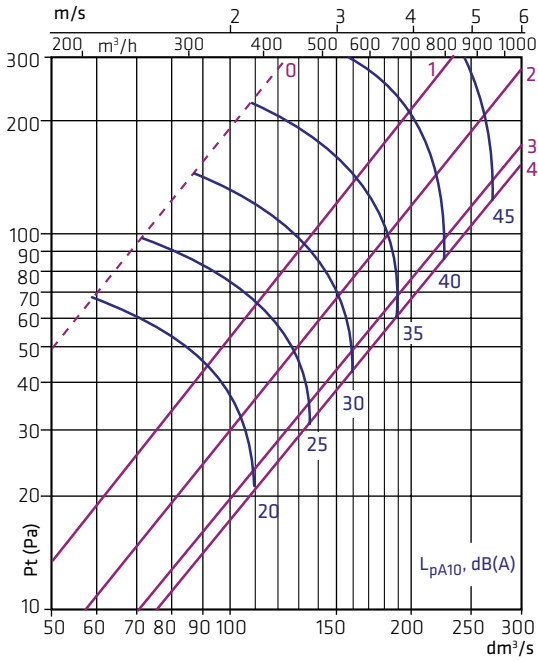

$L_{w_{okt}} = L_{pA10} + K$								
f, Hz	63	125	250	500	1k	2k	4k	8k
K, dB	10	14	8	3	-1	-7	-13	-16

ΔL (dB)								
f, Hz	63	125	250	500	1k	2k	4k	8k
ΔL , dB	18	11	15	21	27	28	24	20

NOT-S-315

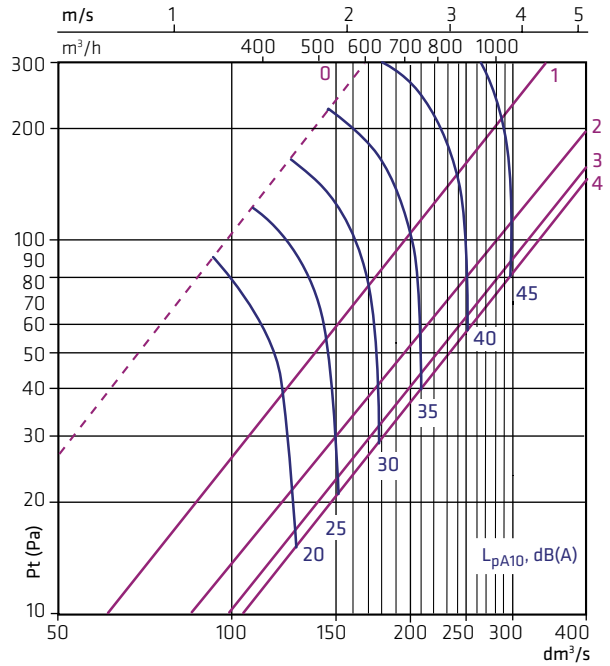

$L_{w_{okt}} = L_{pA10} + K$								
f, Hz	63	125	250	500	1k	2k	4k	8k
K, dB	6	14	8	4	1	-6	-11	-22

ΔL (dB)								
f, Hz	63	125	250	500	1k	2k	4k	8k
ΔL , dB	19	9	15	20	21	25	20	24

NOX dimensioning Airflow - pressure loss - sound level. The graphs are not to be used for adjustment.

NOX-125

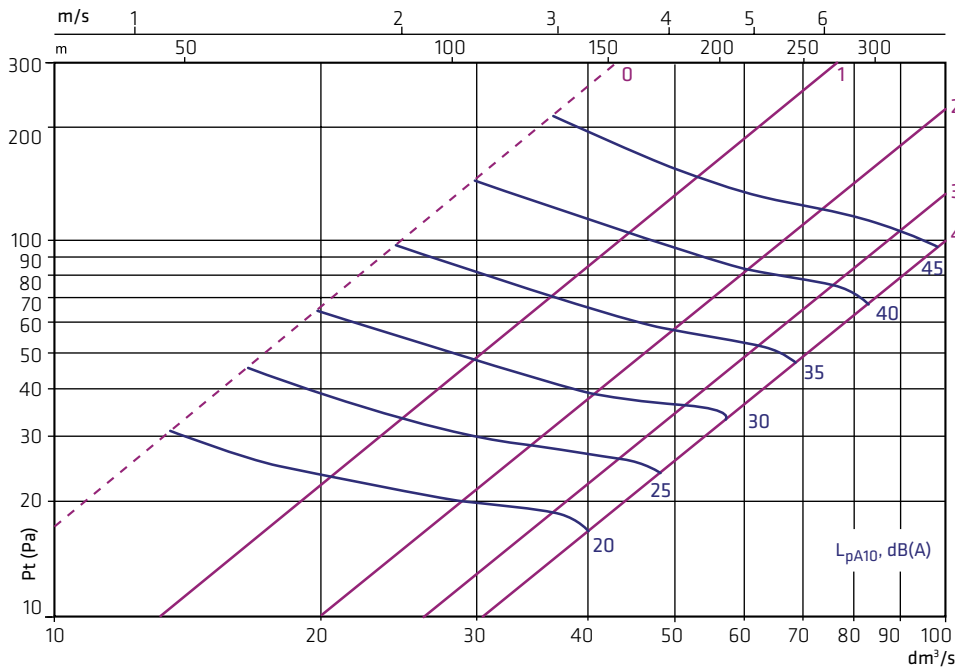

$L_{w\text{okt}} = L_{pA10} + K$

f, Hz	63	125	250	500	1k	2k	4k	8k
K, dB	8	6	9	1	-5	-8	-11	-17

ΔL (dB)

f, Hz	63	125	250	500	1k	2k	4k	8k
ΔL, dB	23	17	9	8	12	9	11	12

NOX-160

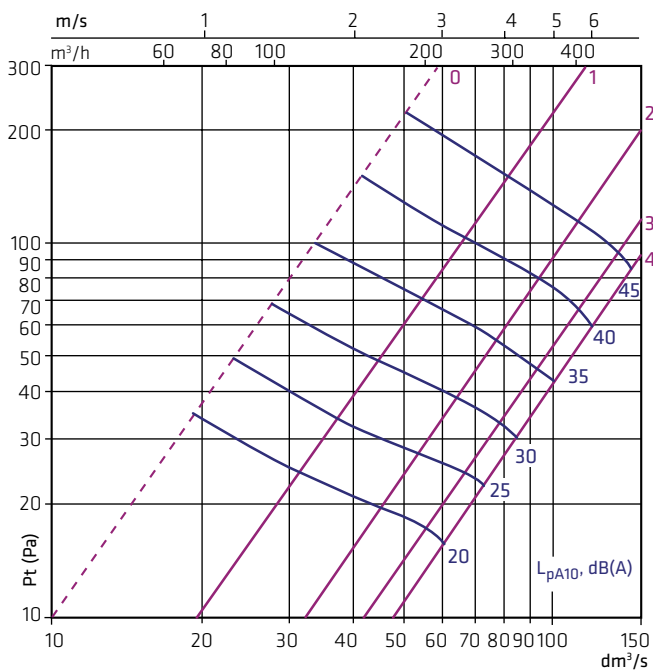

$L_{w\text{okt}} = L_{pA10} + K$

f, Hz	63	125	250	500	1k	2k	4k	8k
K, dB	9	7	9	2	-4	-8	-13	-20

ΔL (dB)

f, Hz	63	125	250	500	1k	2k	4k	8k
ΔL, dB	17	15	8	10	11	8	10	11

NOX dimensioning Airflow - pressure loss - sound level. The graphs are not to be used for adjustment.

NOX-200

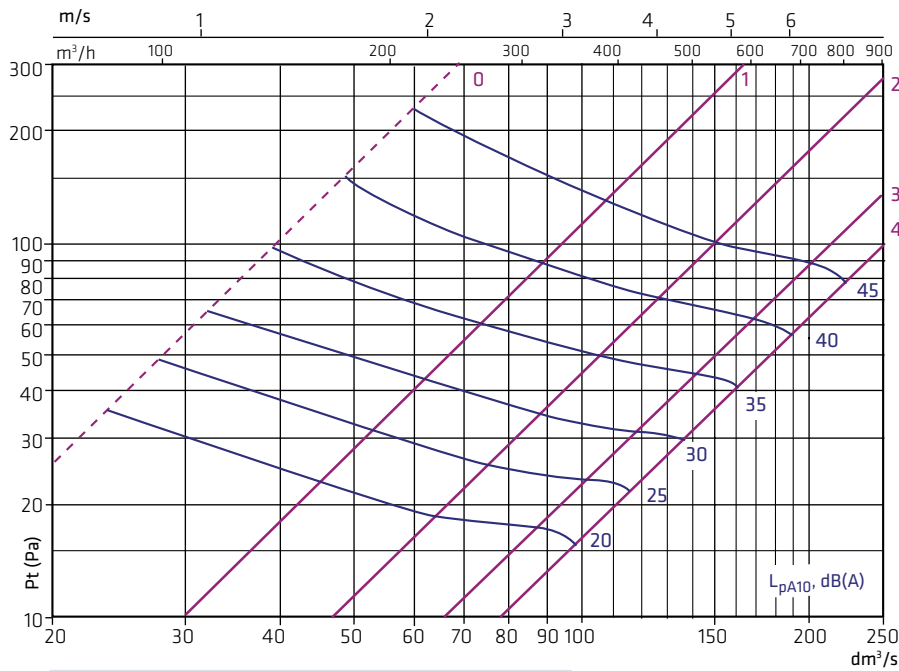

$L_{w\text{okt}} = L_{pA10} + K$

f, Hz	63	125	250	500	1k	2k	4k	8k
K, dB	2	8	8	2	-3	-8	-12	-17

ΔL (dB)

f, Hz	63	125	250	500	1k	2k	4k	8k
ΔL , dB	18	12	5	7	8	7	10	10

NOX-250

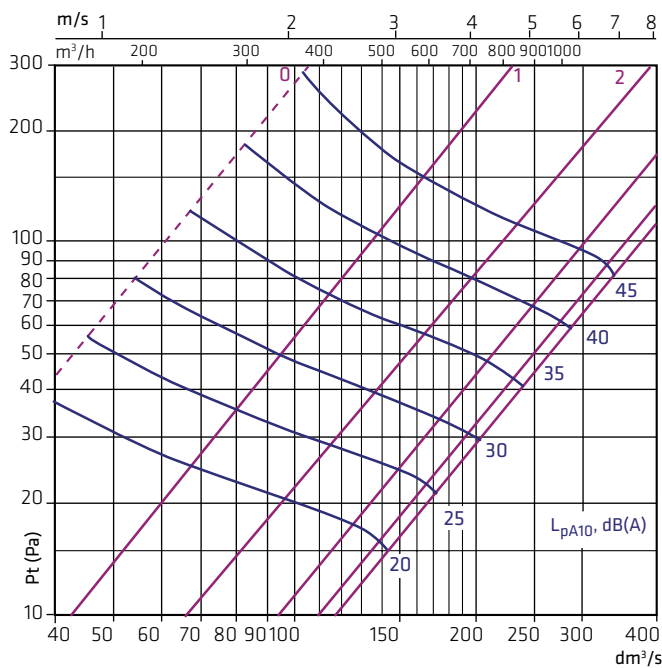

$L_{w\text{okt}} = L_{pA10} + K$

f, Hz	63	125	250	500	1k	2k	4k	8k
K, dB	6	12	9	4	-1	-8	-14	-18

ΔL (dB)

f, Hz	63	125	250	500	1k	2k	4k	8k
ΔL , dB	17	8	6	8	7	8	10	10

NOX-315

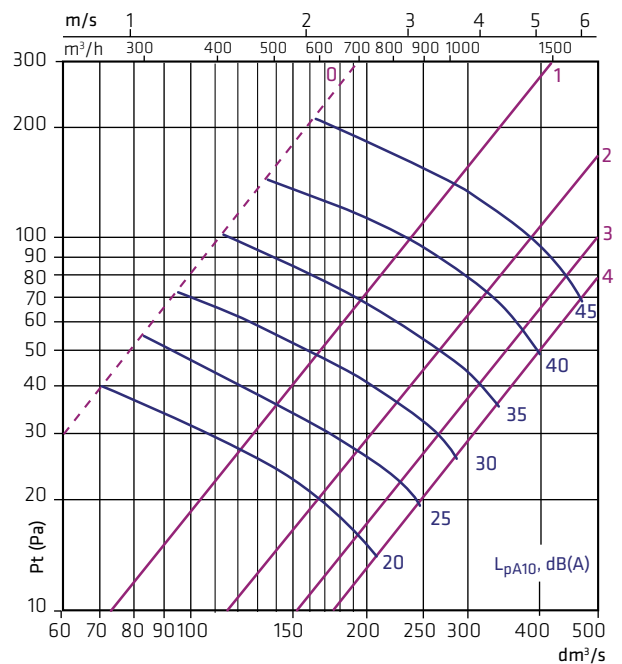

$L_{w\text{okt}} = L_{pA10} + K$

f, Hz	63	125	250	500	1k	2k	4k	8k
K, dB	9	12	8	5	2	-6	-12	-18

ΔL (dB)

f, Hz	63	125	250	500	1k	2k	4k	8k
ΔL , dB	14	8	8	8	6	7	9	10

NOX-S dimensioning Airflow - pressure loss - sound level. The graphs are not to be used for adjustment.

NOX-S-125

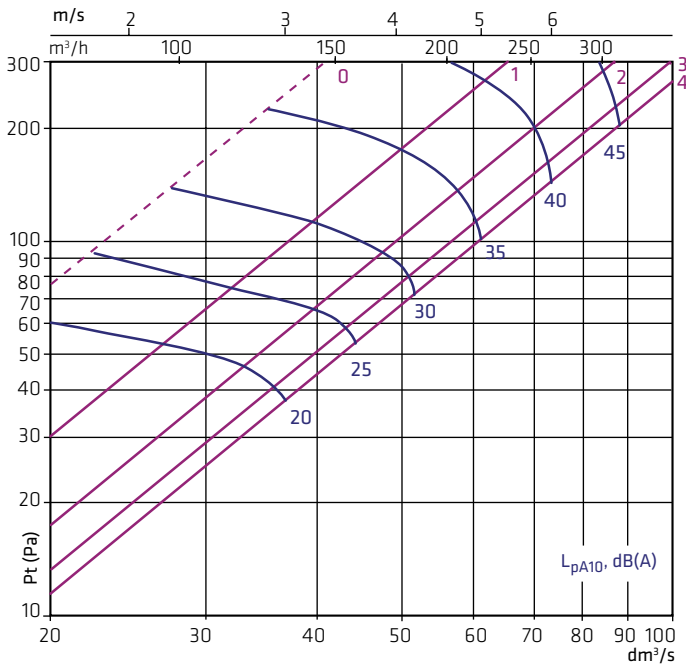

$$L_{w\text{okt}} = L_{pA10} + K$$

f, Hz	63	125	250	500	1k	2k	4k	8k
K, dB	2	6	11	-1	-6	-10	-15	-18

ΔL (dB)

f, Hz	63	125	250	500	1k	2k	4k	8k
ΔL, dB	33	22	16	23	35	32	30	27

NOX-S-160

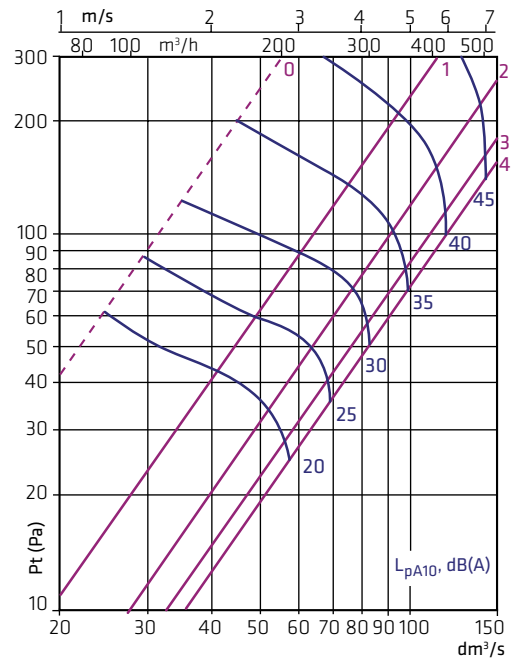

$$L_{w\text{okt}} = L_{pA10} + K$$

f, Hz	63	125	250	500	1k	2k	4k	8k
K, dB	4	10	11	0	-6	-12	-16	-20

ΔL (dB)

f, Hz	63	125	250	500	1k	2k	4k	8k
ΔL, dB	27	19	12	20	29	30	27	21

NOX-S-200

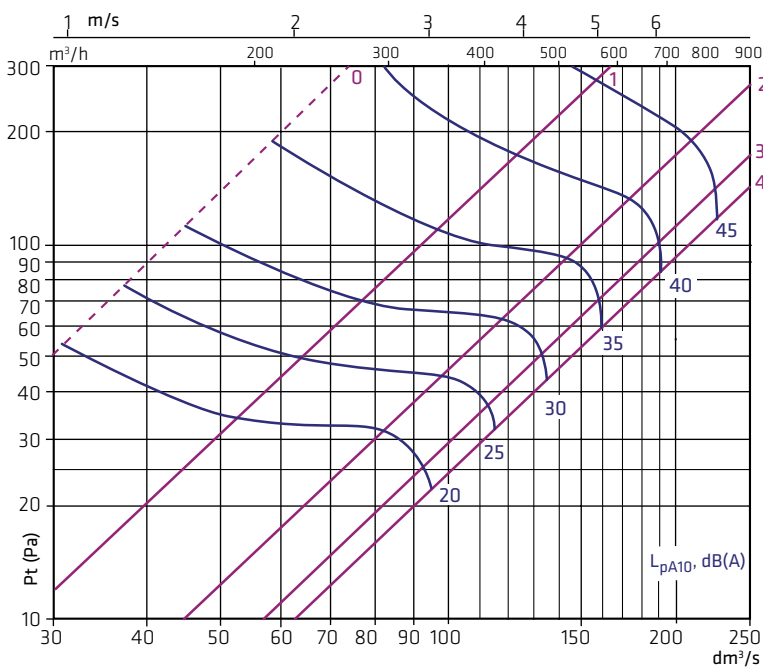

$$L_{w\text{okt}} = L_{pA10} + K$$

f, Hz	63	125	250	500	1k	2k	4k	8k
K, dB	5	10	10	1	-6	-11	-14	-20

ΔL (dB)

f, Hz	63	125	250	500	1k	2k	4k	8k
ΔL, dB	20	13	8	15	26	30	26	19

NOX-S dimensioning Airflow - pressure loss - sound level. The graphs are not to be used for adjustment.

NOX-S-250

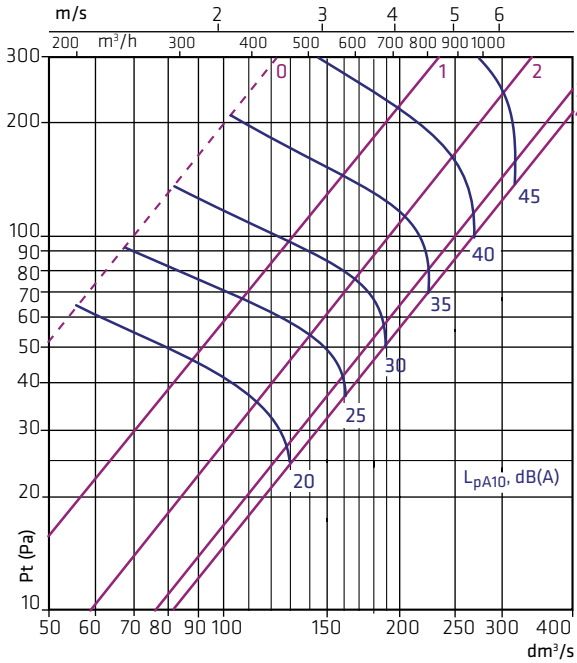

$L_{w_{okt}} = L_{pA10} + K$								
f, Hz	63	125	250	500	1k	2k	4k	8k
K, dB	7	14	9	3	-1	-7	-12	-16

ΔL (dB)								
f, Hz	63	125	250	500	1k	2k	4k	8k
ΔL , dB	18	11	13	20	26	27	24	20

NOX-S-315

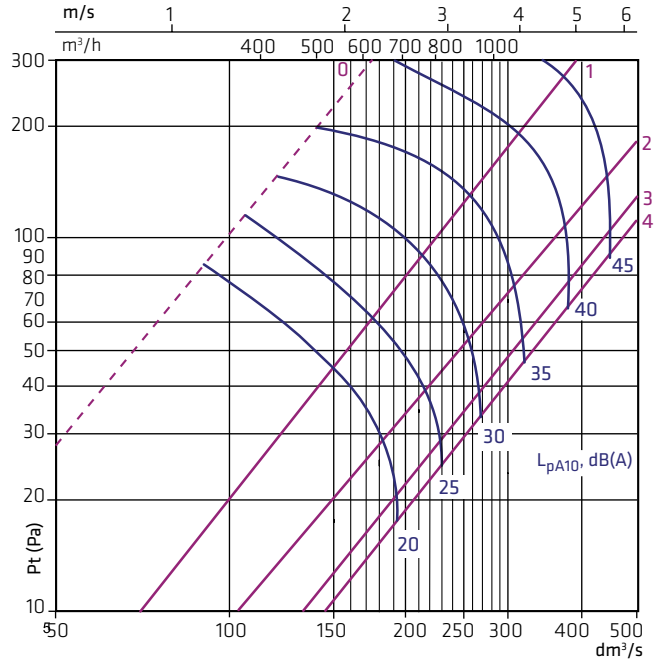

$L_{w_{okt}} = L_{pA10} + K$								
f, Hz	63	125	250	500	1k	2k	4k	8k
K, dB	8	14	9	4	1	-7	-11	-20

ΔL (dB)								
f, Hz	63	125	250	500	1k	2k	4k	8k
ΔL , dB	19	8	13	18	20	24	19	24