



Iris dampers type IRIS

Galvanized steel IRIS air volume control damper of the diaphragm type with pressure measuring points
Available in range from Ø80 up to Ø800 mm

Application

- For air volume control and measurement in ventilation and air conditioning systems.
- The diaphragm valve ensures a perfect accordance between the diameter indication on the handle and the opening of the valve

Material

- Galvanized steel

Composition

- Body and valve made of galvanized sheet steel
- Plastic regulating nut with plastic key
- Measuring point on either side of the valve for connection of manometer
- Sticker with selection graph, mentioning the air volume at the different opening positions of the valve and the according pressure level
- Flexible joints for air tightness when placed inside the duct

Mounting

- To be mounted in between two ducts

Text for tender

- The air volume control dampers shall be of the circular diaphragm type, suitable for medium and high pressure systems. They shall be made of galvanized sheet steel
- ATC Type **IRIS**



Pressure losses and sound levels

IRIS 80

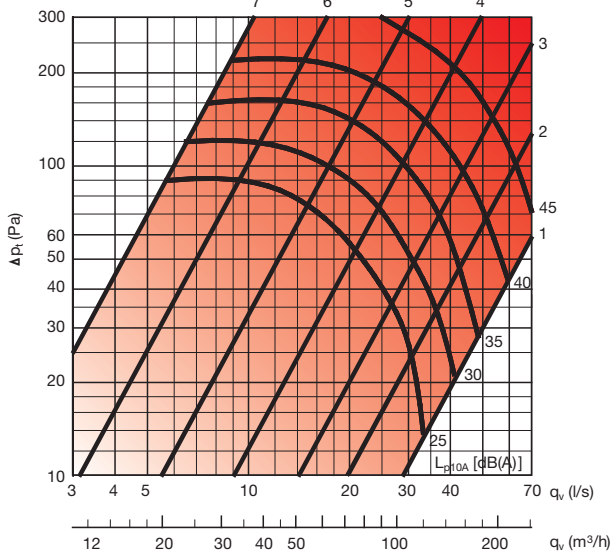

IRIS 100

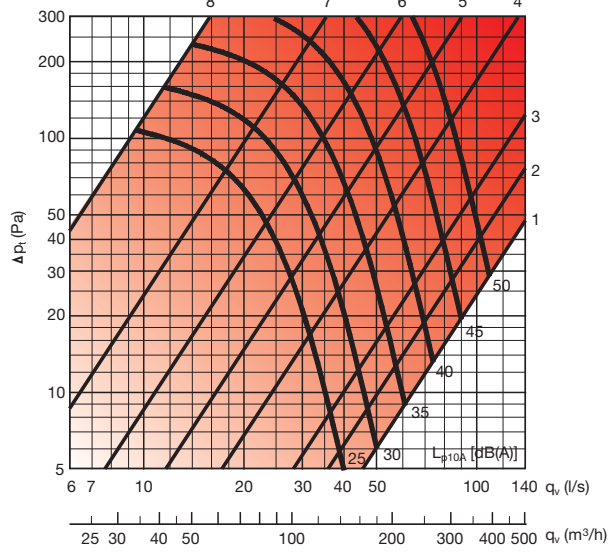

IRIS 125

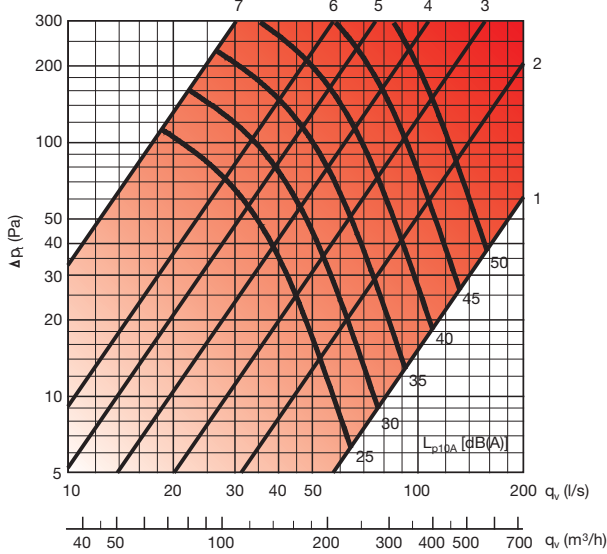

IRIS 150

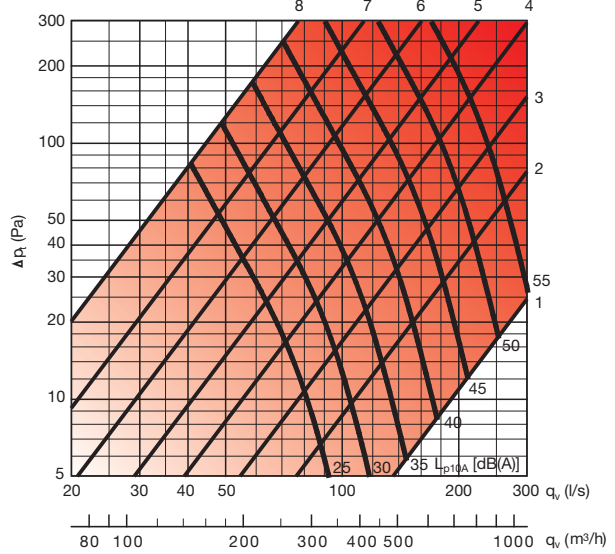

IRIS 160

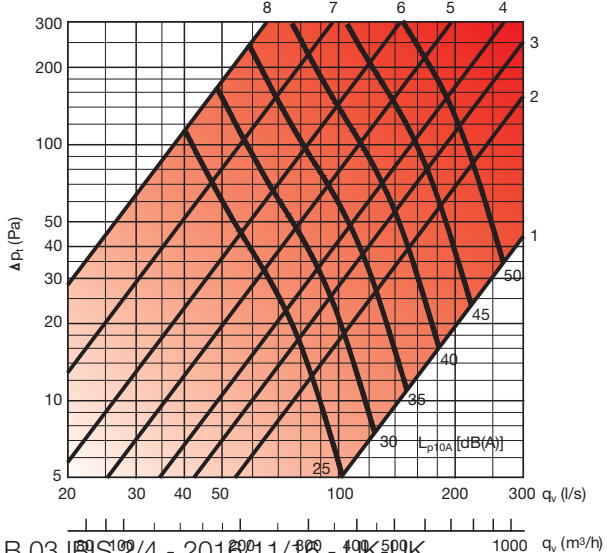

IRIS 200

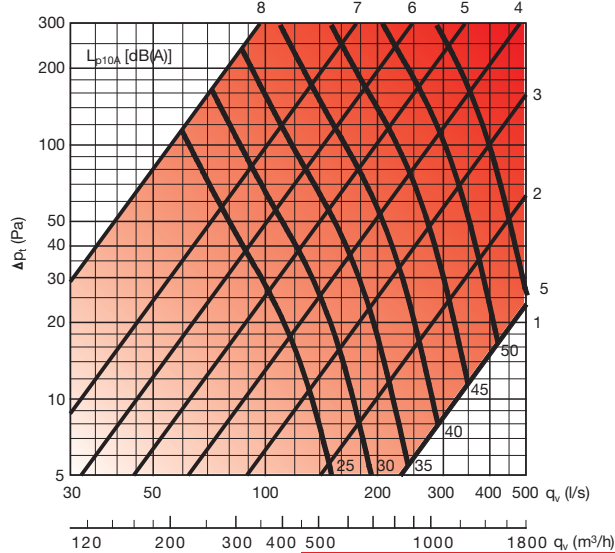

IRIS 250

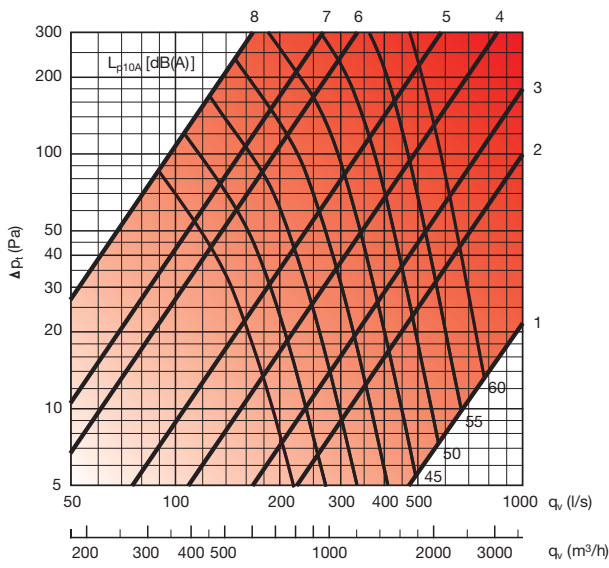

IRIS 315

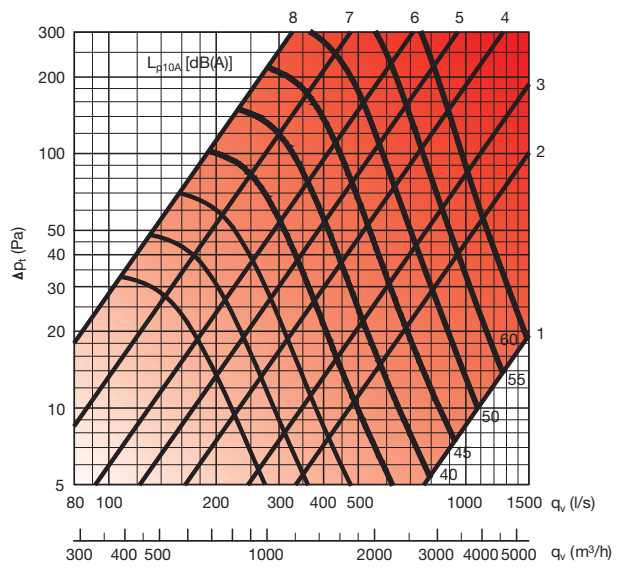

IRIS 400

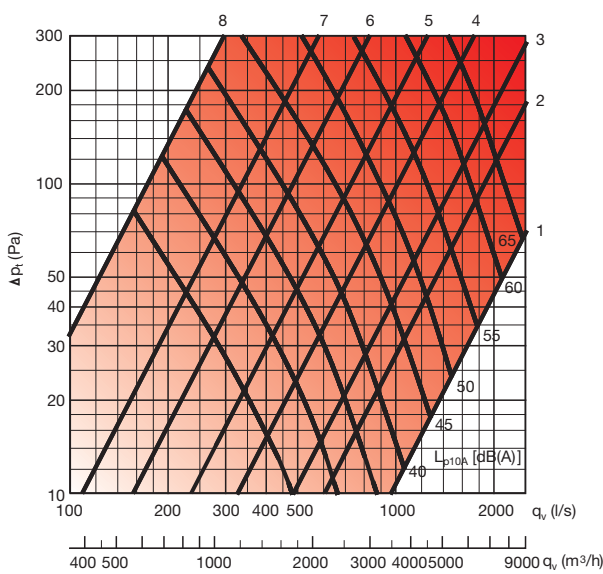

IRIS 500

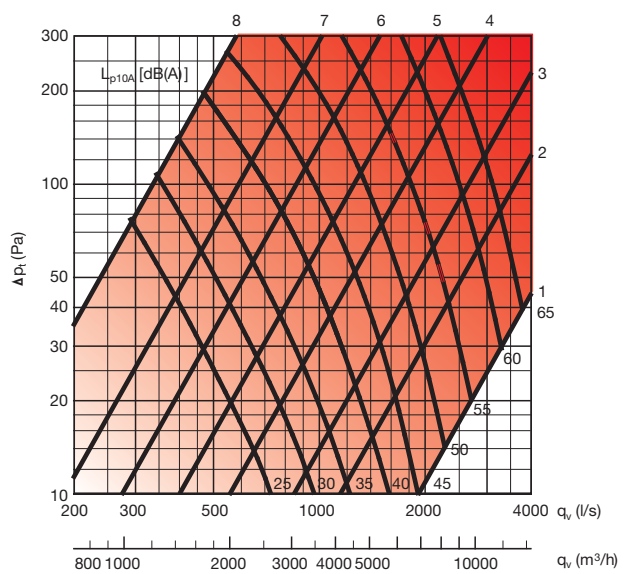

IRIS 630

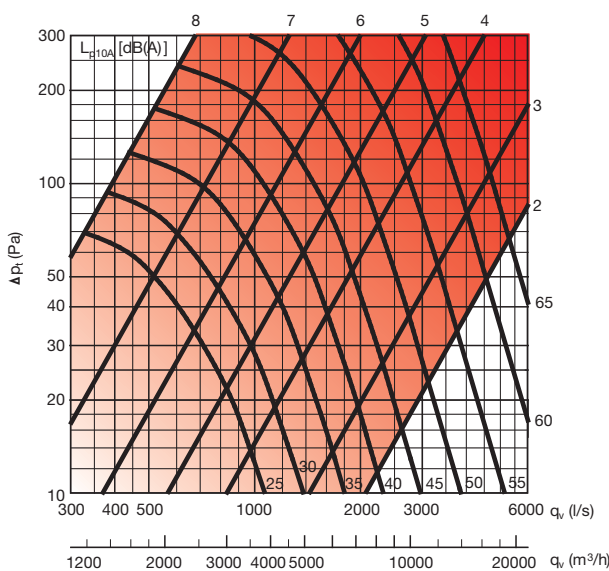

IRIS 800

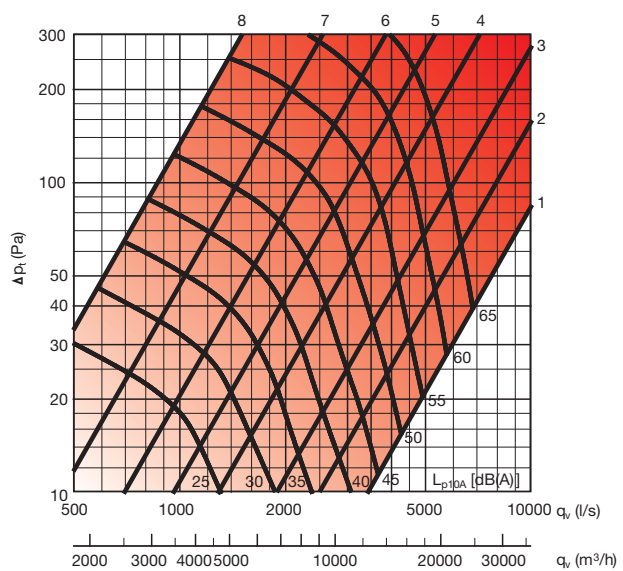

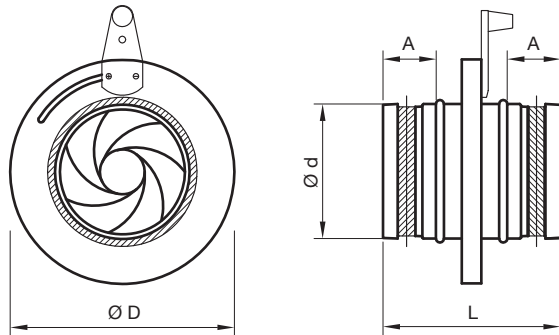
Dimensions

IRIS	ød [mm]	øD [mm]	A [mm]	L [mm]
80	79	125	35	120
100	99	165	30	110
125	124	188	30	110
150	149	230	30	110
160	159	230	30	110
200	199	285	30	110
250	249	335	40	132
315	314	410	40	132
400	398	525	50	155
500	498	655	50	170
630	628	815	50	170
800	798	1015	100	270