

Diffuser for large air flows. Can be installed in wall or ceiling: Selection of narrow or wide throw pattern by rotating the cones. Suitable for heating.

Material and surface treatment

Manufactured of sheet steel. As standard painted grey RAL 7030. Other RAL colours are available at additional costs.

Order key

Jet-diffuser RJA - 200

1 = size 200 - 500 1

Quick guide

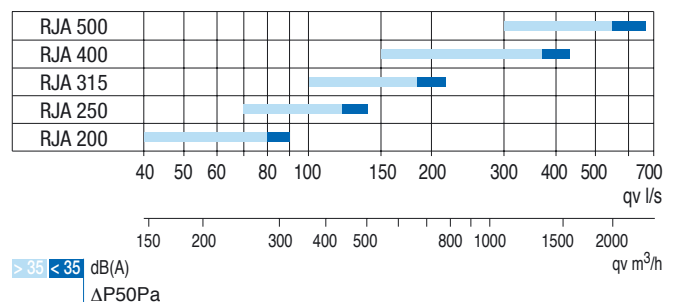

Performance

The graphs are not to be used for commissioning

RJA (N)

Narrow throw

Air flow - pressure drop - sound level

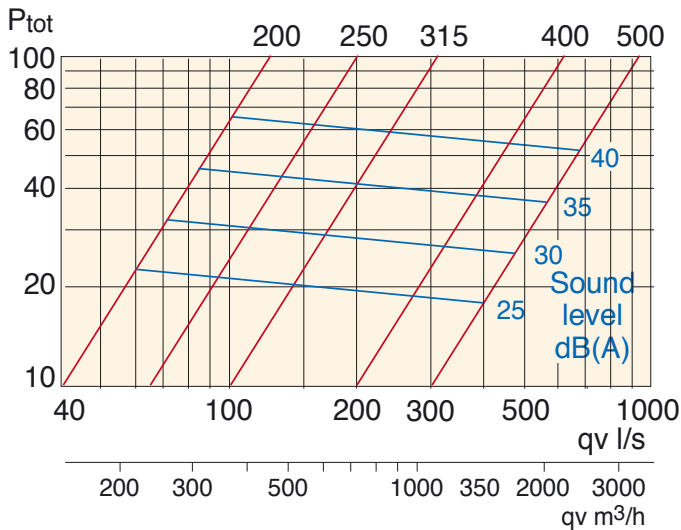

Air flow - throw L_{0,3}

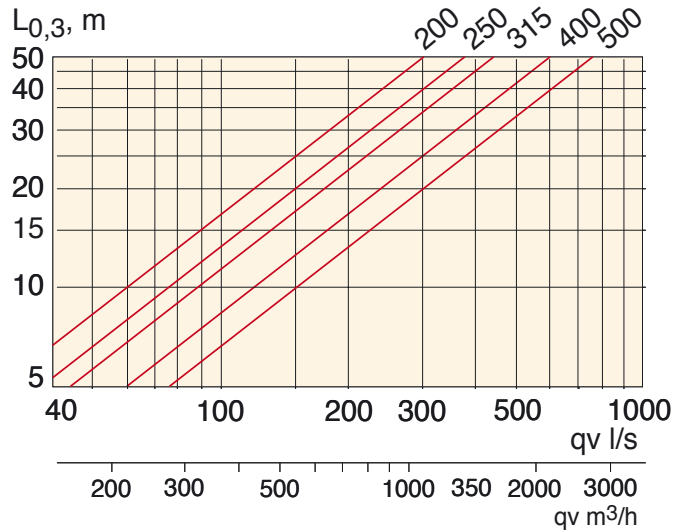

RJA (W)

Wide throw

Air flow - pressure drop - sound level

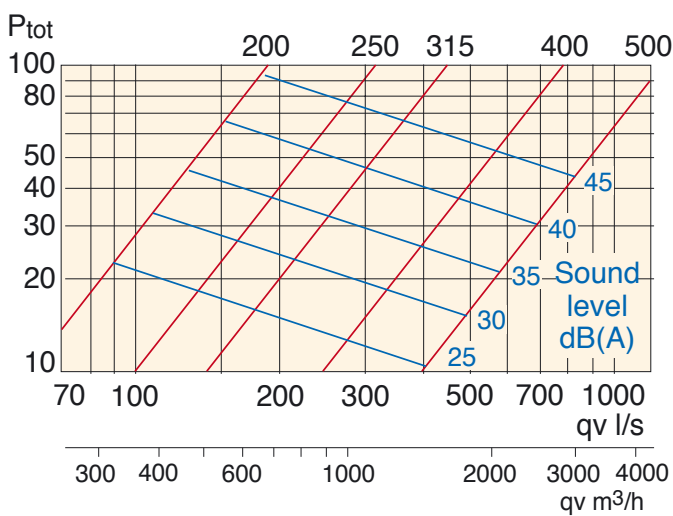

Air flow - throw L_{0,3}

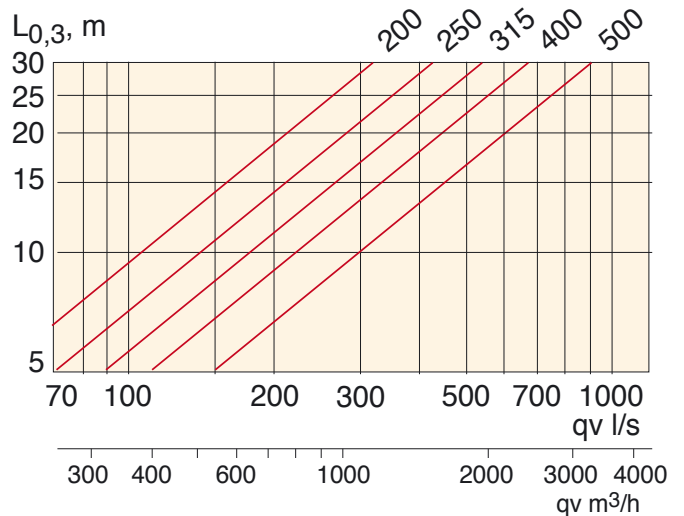

Sound power level L_w , dB

RJA - W (wide)

Size	Hz						
	125	250	500	1k	2k	4k	8k
200	5	2	-2	-3	-3	-18	-19
250	3	1	-3	0	-5	-19	-20
315	4	2	-3	1	-9	-18	-20
400	3	-1	-1	1	-8	-19	-19
500	3	1	4	-1	-11	-24	-26

RJA - N (narrow)

Size	Hz						
	125	250	500	1k	2k	4k	8k
200	7	4	0	-3	-5	-18	-19
250	3	1	-2	0	-5	-19	-20
315	3	1	-1	1	-10	-21	-22
400	4	1	1	0	-10	-20	-20
500	5	2	4	-1	12	-23	-24

Sound attenuation ΔL , dB

Size	Hz						
	125	250	500	1k	2k	4k	8k
200	13	10	4	0	0	0	0
250	11	7	3	0	0	0	0
315	10	6	2	0	0	0	0
400	9	5	1	0	0	0	0
500	7	3	1	0	0	0	0

Throw pattern

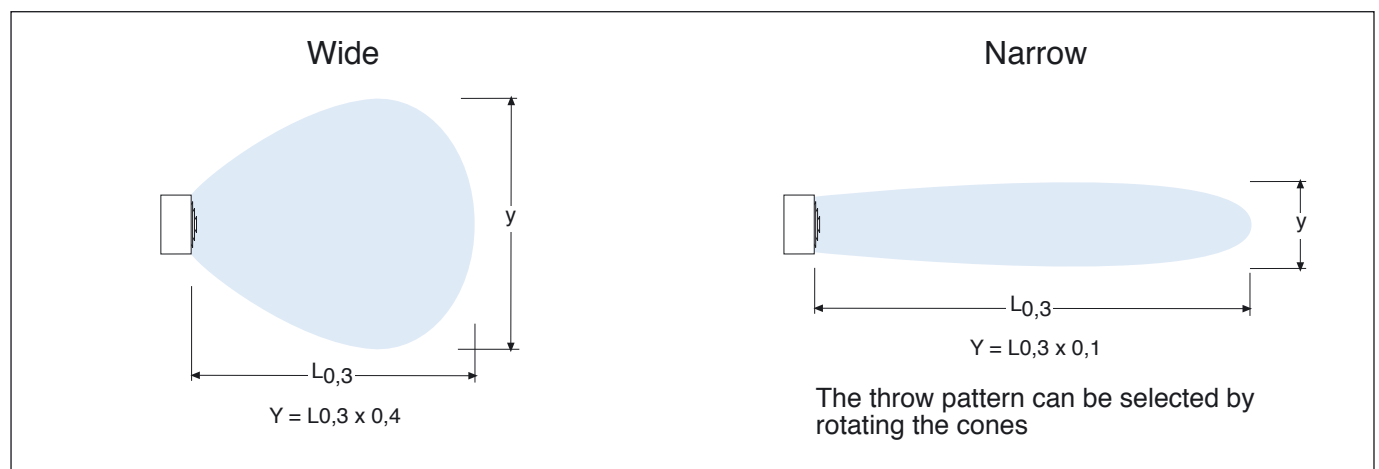

Dimensions

Size	$\emptyset D^*$	E	F	Weight, kg
200	200	140	10	1,4
250	250	150	23	2,0
315	315	180	33	2,8
400	400	220	43	4,1
500	500	270	53	6,0

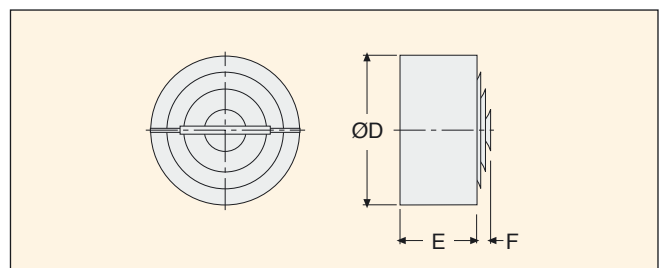

* Note $\emptyset D$ = duct size

Installation

