



TTC80F

Thyristor controller for proportional control of electric heating

TTC80F is a 3-phase controller for electric heating.

- Can control both Y- and Delta-connected loads
- PI-control for supply air control and P-control for room control
- 3-phase 400 V AC +/- 10%

TTC80F is a 3-phase thyristor controller for controlling electric heating up to 80 A. It is intended for DIN-rail mounting in for example an electric cabinet.

TTC80F can control both symmetrical Y-connected 3-phase heaters and symmetrical or asymmetrical Delta-connected heaters.

Function

TTC80F pulses the whole load On - Off. The controller utilises time-proportional control, the ratio between On-time and Off-time is varied to fit the prevailing heating requirement. E.g. On = 30 sec. and Off = 30 sec. gives 50% output power. The cycle-time (the sum of on-time and off-time) is adjustable 6...60 sec.

The control accuracy gives an even temperature, which helps reduce energy costs and increase the comfort level. The current is switched at zero phase angle, which means that any network disturbance is eliminated.

TTC80F automatically adapts its control mode to suit the control object dynamics.

- Minimum and maximum limits adjustable
- A complete controller for use with Regin NTC temperature sensors

Supply air temperature control

For rapid temperature changes (supply air control), TTC80F will function as a PI-controller with a proportional band of 20 K and a reset time of 6 minutes.

Room temperature control

For slow temperature changes (room control), TTC80F will function as a P-controller with a proportional band of 1.5 K. When running room temperature control the supply air temperature can be maximum and/or minimum limited.

Controlling larger electric heaters

At larger loads, TTC80F can be combined with step controller TT-S4/D or TT-S6/D (*see product sheets 2-425 and 2-430*).

External control signal

TTC80F can also be run against a 0...10 V DC control signal from another controller. 0 V input signal will give 0% output and 10 V input will give 100% output.

Minimum and maximum limit functions are not active when using an external control signal.

Technical data

Supply voltage	3-phase 400 V AC +/- 10%, 50...60 Hz
Power output	Max 80 A/phase. Min 5 A/phase. Y- and Delta-connected loads.
Ambient temperature	0...40°C
Storage temperature	-40...+50°C
Humidity	max 90% RH
Protection class	IP20
CE	This product conforms with the requirements of European EMC standards CENELEC EN 61000-6-1 and EN 61000-6-3 and carries the CE mark.
Reset time	(Supply air temperature control) 6 min, fixed
Proportional band	(Supply air temperature control) 20 K, fixed (Room temperature control) 1.5 K, fixed
Indicator	LED that is lit when power is pulsed to the heater
Sensor inputs	Two inputs for main sensor and max/min sensor. Intended for use with Regin's NTC sensors. N.B. Max/min sensor must be 0...60°C.
Setpoint	Selectable, either internal setpoint potentiometer or external setting device
Signal input	0...10 V DC when running against other controllers
Signal output	0...10 V connected to the output unit by wire strap (terminals 7-9)
Setting options	
Setpoint	0...30°C, adjustable. The choice of sensor determines the controller setpoint range.
Minimum limits	0...30°C, adjustable
Maximum limits	20...60°C, adjustable
Cycle time	6...60 seconds, adjustable
Night set-back	Possible by using night set-back unit NS/D

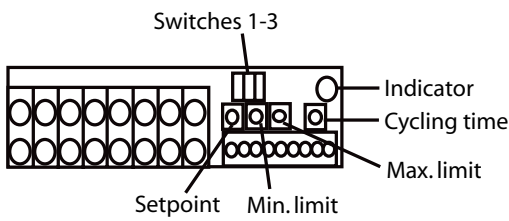

Switches

1. Setpoint
Up: Internal, Down: External
2. Minimum limit
Up: Active, Down: Not active
3. Maximum limit
Up: Active, Down: Not active

Wiring and dimensions

Power

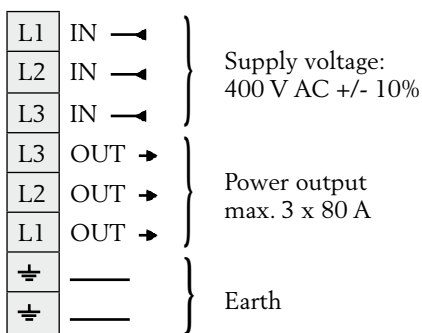

Room temperature control

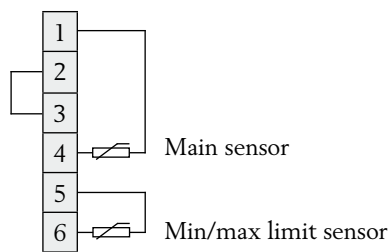

Room temperature control with external setpoint

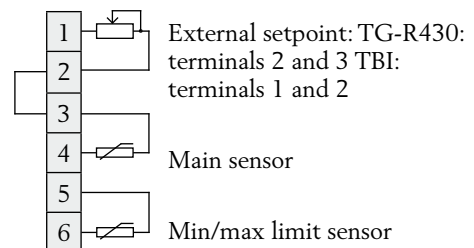

Constant supply air

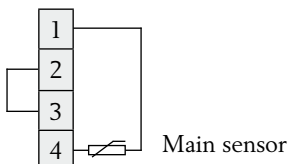

External signal 0...10 V DC

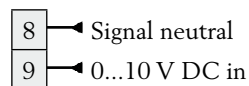

Terminals 7 and 9 are connected by a factory-mounted wire strap. Remove the wire strap when using the external control signal.

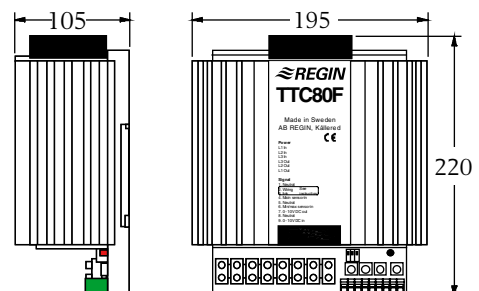

Head Office Sweden
Phone: +46 31 720 02 00
Web: www.regin.se
Mail: info@regin.se

Sales Offices
France: +33 14 171 46 46
Hong Kong: +852 24 07 02 81
Singapore: +65 67 47 82 33

REGIN

THE CHALLENGER IN BUILDING AUTOMATION