



TTC63F

Thyristor controller for proportional control of electric heating

TTC63F is a 3-phase controller for electric heating.

- Can control both Y- and Delta-connected loads
- PI-control for supply air control and P-control for room control
- 3-phase 400 V AC +/- 10%

TTC63F is a 3-phase thyristor controller for controlling electric heating up to 63 A. It is intended for DIN-rail mounting in for example an electric cabinet.

TTC63F can control both symmetrical Y-connected 3-phase heaters and symmetrical or asymmetrical Delta-connected heaters.

Function

TTC63F pulses the whole load On - Off. The controller utilises time-proportional control, the ratio between On-time and Off-time is varied to fit the prevailing heating requirement. E.g. On = 30 sec. and Off = 30 sec. gives 50% output power. The cycle-time (the sum of on-time and off-time) is adjustable 6...60 sec.

The control accuracy gives an even temperature, which helps reduce energy costs and increase the comfort level. The current is switched at zero phase angle, which means that any network disturbance is eliminated.

TTC63F automatically adapts its control mode to suit the control object dynamics.

- Minimum and maximum limits adjustable
- A complete controller for use with Regin NTC temperature sensors

Supply air temperature control

For rapid temperature changes (supply air control), TTC63F will function as a PI-controller with a proportional band of 20 K and a reset time of 6 minutes.

Room temperature control

For slow temperature changes (room control), TTC63F will function as a P-controller with a proportional band of 1.5 K. When running room temperature control the supply air temperature can be maximum and/or minimum limited.

Controlling larger electric heaters

At larger loads, TTC63F can be combined with step controller TT-S4/D or TT-S6/D (*see product sheets 2-425 and 2-430*).

External control signal

TTC63F can also be run against a 0...10 V DC control signal from another controller. 0 V input signal will give 0% output and 10 V input will give 100% output.

Minimum and maximum limit functions are not active when using an external control signal.

Technical data

| | |
|---------------------|--|
| Supply voltage | 3-phase 400 V AC +/- 10%, 50...60 Hz. |
| Power output | Max 63 A/phase. Min 5 A/phase. Y- and Delta-connected loads. |
| Ambient temperature | 0...40°C |
| Storage temperature | -40...+50°C. |
| Humidity | max 90% RH |
| Protection class | IP20 |
| CE | This product conforms with the requirements of European EMC standards CENELEC EN 61000-6-1 and EN 61000-6-3 and carries the CE mark. |
| Reset time | (Supply air temperature control) 6 min, fixed |
| Proportional band | (Supply air temperature control) 20 K, fixed (Room temperature control) 1.5 K, fixed |
| Indicator | LED that is lit when power is pulsed to the heater |
| Sensor inputs | Two inputs for main sensor and max/min sensor. Intended for use with Regin's NTC sensors. N.B. Max/min sensor must be 0...60°C. |
| Setpoint | Selectable, either internal setpoint potentiometer or external setting device |
| Signal input | 0...10 V DC when running against other controllers |
| Signal output | 0...10 V connected to the output unit by wire strap (terminals 7-9) |

Setting options

| | |
|----------------|--|
| Setpoint | 0...30°C, adjustable. The choice of sensor determines the controller setpoint range. |
| Minimum limits | 0...30°C, adjustable |
| Maximum limits | 20...60°C, adjustable |
| Cycle time | 6...60 seconds, adjustable |
| Night set-back | Possible by using night set-back unit NS/D |

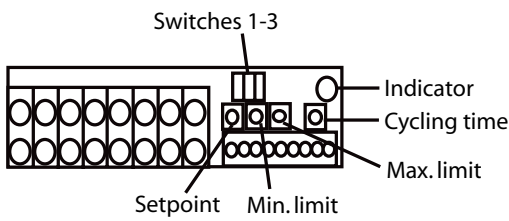

Switches

1. Setpoint
Up: Internal, Down: External
2. Minimum limit
Up: Active, Down: Not active
3. Maximum limit
Up: Active, Down: Not active

Wiring and dimensions

Power

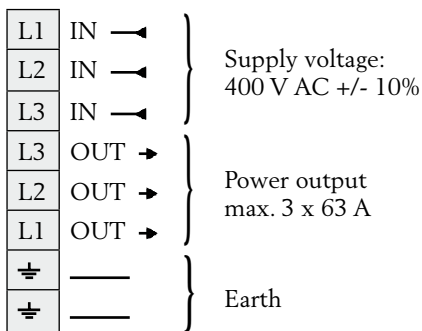

Room temperature control

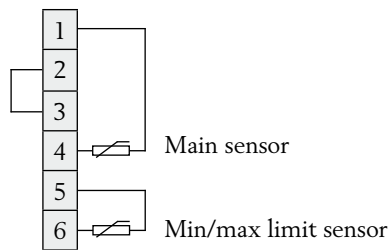

Room temperature control with external setpoint

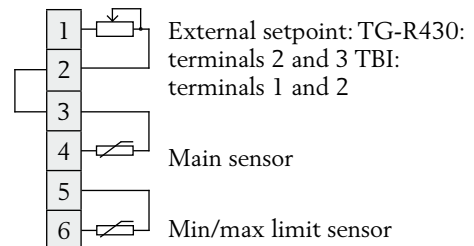

Constant supply air

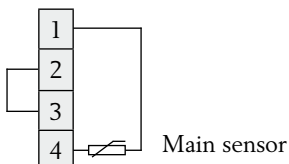

External signal 0...10 V DC

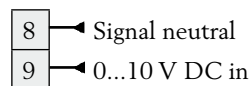

Terminals 7 and 9 are connected by a factory-mounted wire strap. Remove the wire strap when using the external control signal.

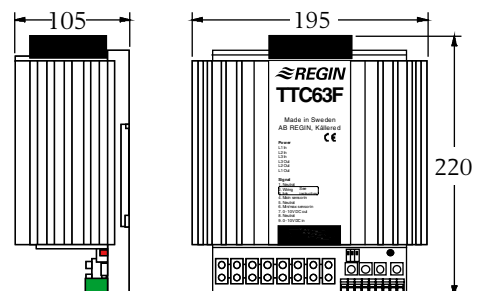

Head Office Sweden
Phone: +46 31 720 02 00
Web: www.regin.se
Mail: info@regin.se

Sales Offices
France: +33 14 171 46 46
Hong Kong: +852 24 07 02 81
Singapore: +65 67 47 82 33

REGIN

THE CHALLENGER IN BUILDING AUTOMATION